

CASIO®

Handheld Terminal

DT-930

Series

User's Guide



- Be sure to read "Safety Precautions" inside this guide before trying to use your Handheld Terminal. After reading this guide, keep it in a safe place for future reference.



BLUETOOTH is a registered trademark owned by Bluetooth SIG. Inc. and licensed to CASIO COMPUTER CO., LTD.

Safety Precautions

Congratulations upon your selection of this CASIO Product. Be sure to read the following Safety Precautions before trying to use it for the first time. Keep this manual in a handy place for future reference.

Markings and Symbols

The following are the meanings of the markings and symbols used in these Safety Precautions to warn you against the possibility of personal injury and/or material damage or loss to you and others. Take a few moments to become familiar with these markings and symbols so you can avoid future problems.



Danger!

This symbol indicates information that, if ignored or applied incorrectly, creates the danger of death or serious personal injury.



Warning!

This symbol indicates information that, if ignored or applied incorrectly, can create the possibility of death or serious personal injury.



Caution!

This symbol indicates information that, if ignored or applied incorrectly, can create the possibility of personal injury or material damage.

Marking examples



A triangular shape indicates you should exercise caution. The symbol shown here indicates you should take care to avoid breakage.



A circle indicates something you should not do. This symbol indicates you should not try to take something apart.



A black circle indicates something you must do. This symbol indicates you should unplug power cord.

Danger!

■ **Lithium-ion Battery Pack**

The Lithium-ion Battery Pack is available as an option.



- Never allow the battery pack to become wet. Water can create the danger of battery pack heat emission, explosion, and fire.
- Never use or leave the battery pack next to open flame, near a stove, or any other area exposed to high heat. Doing so creates the danger of battery pack heat emission, explosion, and fire.
- Never use the battery pack with any device other than this unit. Doing so can create the danger of battery pack heat emission, explosion, and fire.
- Note that the battery pack's positive (+) and negative (-) terminals must be oriented correctly when it is loaded into the charger unit or the Data Collector. Connecting the battery pack with its terminals reversed creates the danger of battery pack fluid leakage, heat emission, explosion, and fire.
- Never dispose of the battery pack by incinerating it or otherwise expose it to heat. Doing so creates the danger of battery pack heat emission, explosion, and fire.
- Never allow the positive (+) and negative (-) terminals of the battery pack to become connected (shorted) by metal. Doing so creates the danger of battery pack heat emission, explosion, and fire.
- Never transport or store the battery pack together with a necklace, hair pins or other metal objects. Doing so can short battery pack terminals, creating the danger of battery pack heat emission, explosion, and fire. Be sure to place the battery pack in its case whenever transporting or storing it.
- Never throw the battery pack or otherwise subject it to strong impact. Doing so creates the danger of battery pack heat emission, explosion, and fire.
- Never pierce the battery pack with nails, hit it with a hammer, or step on it. Doing so can create the danger of battery pack heat emission, explosion, and fire.
- Never try to take apart the battery pack or modify it in any way. Doing so creates the danger of battery pack heat emission, explosion, and fire.



- Use only the specified charger unit to charge the battery pack. Use of other types of charger units creates the danger of battery pack heat emission, explosion, and fire.

■ **Handling Alkaline Batteries**



- Should fluid from the alkaline batteries accidentally get into your eyes, there is a threat of loss of eyesight, do not rub them. Immediately rinse your eyes with clean tap water and then consult a physician immediately.

Warning!

■ **Disassembly and Modification**



- Never try to disassemble or modify the unit in any way. High voltage inside creates the danger of electrical shock.

■ **Interior Parts and Components**



- Never touch interior high-voltage parts or components. Doing so creates the danger of electrical shock.

■ **Abnormal Conditions**



- Should the unit become hot or start to emit smoke or a strange odor, immediately turn off the power and contact your original dealer or an authorized CASIO service provider. Continued use creates the danger of fire and electrical shock.

■ **Foreign Objects**



- Should any foreign matter ever get into the unit, immediately turn off the power and contact your original dealer or an authorized CASIO service provider. Continued use creates the danger of fire and electrical shock.

■ **Dropping and Damage**



- Should you drop the unit and damage it, immediately turn off the power and contact your original dealer or an authorized CASIO service provider. Continued use creates the danger of fire and electrical shock.

■ **Moisture**



- Keep the unit away from vases, planters, cups, glasses and other containers of liquid. Also keep it away from metal. Water and metal getting into the unit creates the danger of fire and electrical shock.

■ **Laser Beam**



- Never look directly into the laser beam. Doing so can cause serious eye damage.

Warning!

■ **Interference with the Operation of Other Equipment (Using Wireless Communication)**



- Keep your Handheld Terminal at least 22 centimeters (8' 1/10") away from anyone wearing a pacemaker. Radio waves emitted by the Handheld Terminal can affect the operation of a pacemaker.
- In order to protect someone wearing a pacemaker from the risk of unintentional interference, turn off the Handheld Terminal before boarding a crowded train or entering any other crowded area.

■ **Handling Alkaline Batteries**



- Do not put the battery in a fire, expose it to heat, dismantle or modify it. If the insulation or safety valve is damaged, the battery may leak fluid, overheat or explode.
- Do not insert the battery with the poles reversed. Doing so may cause some abnormality or a short and the battery may leak fluid, overheat or explode.



- Keep the battery out of the reach of children. If the battery is swallowed, contact a physician immediately.
- If the alkali fluid gets in your mouth, rinse your mouth with water and contact a physician immediately.
- If the alkali fluid gets on your skin or clothes, it may burn your skin, thoroughly rinse the affected area with tap water.



- Do not store batteries with metal objects such as necklaces or hairpins, doing so may cause the positive and negative poles to be shorted.
- Do not mix new and old batteries or other makes of batteries. The different attributes may cause the battery to leak fluid, overheat or explode.
- This battery was not made to be recharged. Recharging this battery may damage the insulation or internal structure and may cause the battery to leak fluid, overheat or explode.



- Do not damage or remove the label on the exterior of the battery. Doing so may cause the battery to short, leak fluid, overheat or explode.
- Do not drop, throw or expose the battery to extreme impact. Doing so may cause the battery to leak fluid, overheat or explode.
- Do not alter the shape of the battery. If the insulation or safety valve is damaged, the battery may leak fluid, overheat or explode.

Warning!

■ **Handling the Coin Type Lithium Battery**



- Do not recharge coin type lithium battery. Doing so may cause it to leak fluid, overheat, explode or burst into flames.
- Do not put the coin type lithium battery in open flame, or apply solder directly to the coin type lithium battery. Doing so may cause it to leak fluid, overheat, explode or burst into flames.
- Do not use the coin type lithium battery with the positive and negative poles reversed. Do not store it with metal objects such as necklaces or hairpins, doing so may cause the positive and negative poles to be shorted.



- Keep the coin type lithium battery out of the reach of children. If it is swallowed, contact a physician immediately.
- If the alkali fluid gets in your eye, rinse the eye with water and contact a physician immediately.
- If the alkali fluid gets in your mouth, rinse your mouth with water and contact a physician immediately.
- If the coin type lithium battery leaks fluid or emits a strange smell, immediately remove it from near heat or flames. Burning may cause it to explode or burst into flames.
- When storing or disposing of the coin type lithium battery, cover the terminals with tape to insulate them. Mixing them with other batteries or metal objects may cause the coin type lithium battery to short, leak fluid, overheat, explode or burst into flames.

■ **Lithium-ion Battery Pack**



- Do not put a battery pack in microwave ovens or pressure cookers. Doing so may cause the battery pack to overheat, explode or burst into flames.
- Do not use a battery pack that smells strange, is overheating, is a strange color, or is a strange shape. Doing so may cause the battery pack to overheat, explode or burst into flames.



- If the amount of time period the battery pack can serve becomes considerably short, stop using it. It may indicate the possibility of a malfunction in the battery pack. Continued charging the battery pack creates the danger of heat emission, explosion, and fire.
- Stop charging the battery pack after the recommended time even if it is not fully charged. Continuing to charge the battery may cause the battery pack to overheat, explode or burst into flames.
- If the battery pack leaks fluid or emits a strange smell, remove it from near heat or flames. Burning may cause the battery pack to explode or burst into flames.
- Should fluid from the battery pack accidentally get into your eyes, do not rub them. Immediately rinse your eyes with clean water such as tap water and then consult a physician immediately.

Warning!

■ **Optional Bridge Basic Cradle, Basic Cradle, Satellite Cradle and Cradle-type Battery Charger**



- Power these cradles and Cradle-type battery charger only with a power outlet whose voltage matches that marked on the rating plate of each option. Do not plug these options into an extension shared by other appliances. Doing so creates the danger of fire and electrical shock.
- Avoid conditions that can cause damage or breaks in the power cord. Do not place heavy objects on the power cord. Keep it away from sources of heat. Any of these conditions can damage the power cord, creating the danger of fire and electrical shock.
- Never modify, sharply bend, twist, or pull on the power cord. Doing so creates the danger of fire and electrical shock.



- Use only the AC adaptors and chargers specified in this manual. Use of other AC adaptor models or chargers creates the danger of fire and electrical shock.
- Should the power cord ever become severely damaged (to the point that wires are exposed or broken), contact your original dealer or CASIO service provider for repair or replacement. Use of a damaged electrical cord creates the danger of fire and electrical shock.

Caution!

■ **Foreign Objects**



- Take care to ensure that metal or combustible objects are not inserted into the openings of the unit. Such objects create the danger of fire and electrical shock.

■ **Location**



- Do not locate the unit on a surface that is unstable or uneven. Doing so creates the danger of the unit falling, which can cause personal injury.
- Do not locate the unit in an area subjected to large amounts of humidity or dust. Doing so creates the danger of fire and electrical shock.
- Do not leave the unit for long periods in a car parked in direct sunlight.

■ **Heavy Objects**



- Never place heavy objects on top of the unit. Doing so creates the risk of a loss of balance and the object falling, which can cause personal injury.

Caution!

■ **LCD Screen**



- Never apply strong pressure to the screen or subject it to strong impact. Doing so can crack the LCD panel glass and create the danger of personal injury.
- Should the LCD panel glass ever break, never touch the liquid inside. Doing so can cause skin irritation and inflammation.
 - Should liquid from the LCD panel accidentally get into your mouth, immediately wash your mouth with water and then consult a physician.
 - Should liquid from the LCD panel accidentally get into your eyes or onto your skin, immediately rinse for at least 15 minutes with clean tap water and then consult a physician.

■ **Lithium-ion Battery Pack**



- Never leave the battery pack in an area expose to direct sunlight, in a car parked in direct sunlight, or any other very hot area. Doing so creates the danger of heat emission and fire, as well as deterioration of battery pack performance and shortening of its service life.
- Do not use the battery pack in areas where static electricity is being generated. Doing so creates the danger of battery pack heat emission, explosion, and fire.



- Temperature ranges for battery pack use, charging, and storage are specified below. Temperatures outside these ranges create the danger of deterioration of battery pack performance and shortening of its service life, as well as fluid leakage and heat generation.
 - Operating Temperature: -20°C to 50°C
 - Charging Temperature: 0°C to 40°C
 - Storage Temperature: -20°C to 60°C
- Should fluid from the battery pack accidentally get onto clothing or your skin, immediately rinse it off with clean tap water. Prolonged contact with battery pack fluid can cause skin irritation.
- Keep the battery pack out of the reach of small children. Do not let small children remove the battery pack from the charger unit or the unit it is powering.

Caution!

■ **Handling Alkaline Batteries**



- Store batteries someplace out of direct sunlight where the temperature and humidity are not high. Not doing so may cause the batteries to leak fluid, overheat or explode. Also, it may cause the life and performance of the batteries to decline.
- These batteries can be disposed of as regular garbage, however, if applicable, follow the regulations of the local government when disposing of these batteries.



- Immediately remove batteries when they have lost all power. Leaving the batteries in the unit for a long time may cause the batteries to leak fluid, overheat or explode due to gas that is generated by the batteries.
- Remove the batteries from the unit when not using the unit for an extended period of time. The batteries may leak fluid, overheat or explode due to gas that is generated by the batteries.



- Do not apply solder directly to the batteries. The heat may cause the batteries to leak fluid, overheat or explode.
- Do not store the batteries in the direct sunlight or in a car on a sunny day when it is very hot. The batteries may leak fluid, overheat or explode.



- When storing or disposing of the batteries, cover the terminals with tape to insulate them. Mixing them with other batteries or metal objects may cause the batteries to leak fluid, overheat or explode.



- Do not get the batteries wet. Doing so may cause the batteries to overheat.

■ **Handling the Coin Type Lithium Battery**



- Do not drop, expose to severe impact or alter the shape of the coin type lithium battery. Also, do not get the battery wet. Doing so may cause it to leak fluid, overheat or explode.
- Do not store the coin type lithium battery in the direct sunlight or in a car on a sunny day when it is very hot. It may leak fluid, overheat or explode.



- Store the coin type lithium battery someplace out of direct sunlight where the temperature and humidity are not high. Not doing so may cause it to leak fluid, overheat or explode. Also, it may cause the life and performance of the battery to decline.
- The coin type lithium battery can be disposed of following the instruction or guide issued by your municipal office.

Caution!

■ **Optional Bridge Basic Cradle, Basic Cradle, Satellite Cradle and Cradle-type Battery Charger**



- Keep the power cord away from stoves and other sources of extreme heat. Heat can melt the insulation of the power cord and create the danger of fire and electrical shock.
- Never pull on the power cord when unplugging it. Doing so can damage the cord and create the danger of personal injury, fire and electrical shock. Always hold onto the plug when unplugging it from the wall outlet.
- Never touch the plug while your hands are wet. Doing so can create the danger of electrical shock.



- Be sure to unplug the power cord from the wall outlet before moving the optional cradles and Cradle-type Battery Charger. Failure to do so can result in damage to the power cord caused by pulling it, which creates the danger of fire and electrical shock.
- Be sure to unplug the power cord from the wall outlet before cleaning the optional cradles and Cradle-type Battery Charger.
- Be sure to turn the power OFF and unplug the power cord after use.
- Unplug the power cord from the wall outlet and clean the area around the plugs at least once a year. If dust collects on the AC adaptor, humidity or moisture may cause a fault in the insulation, which may result in a fire.



- The housing of the AC adaptor can become warm during normal use.



- Take normal precautions against electric shock.

Make back-up copies of all important data

Caution!



- Note that CASIO Computer Co., Ltd. shall not be liable to you or any third party for any damages or loss caused by deletion or corruption of data due to use of this, malfunction or repair of this unit or its peripherals, or due to batteries going dead.
- This unit employs electronic memory to store data, which means that memory contents can be corrupted or deleted if the power is interrupted due to batteries going dead or incorrect battery replacement procedures. Data cannot be recovered once it is lost or corrupted. Be sure to make back-up copies of all important data. One way to do this is to use either one of the Bridge Basic Cradle, Basic Cradle and Satellite Cradle to transfer data to a computer.

■ Introduction

Make sure you carefully read the following information to ensure that your Handheld Terminal is able to perform at the level for which it is designed.

Handling Precautions

- Do not throw or drop the Handheld Terminal or otherwise subject it to strong impact, which can damage the LCD screen, interrupt program execution, corrupt memory contents, or otherwise interfere with proper operation.
- Use only your finger or a blunt object to operate the stroke keys. Use of a sharp pointed object can damage stroke keys and cause shorting of internal circuitry.
- Use a soft, dry cloth when cleaning the Handheld Terminal. Do not wipe with a wet cloth. Do not use benzine, thinner, or other volatile chemicals, which can result in deformation and deterioration of the materials used in the keys and case.
- Do not lay the Handheld Terminal down with its key panel downwards. Doing so runs the risk of accidental key operation, which can cause malfunction.
- Never remove the main battery while Handheld Terminal power is turned ON. Doing so can cause all data in memory to be lost.
- Sudden temperature changes can cause condensation to form on the Handheld Terminal's case. Operating the Handheld Terminal while condensation is present can interfere with proper operation. Take care to avoid conditions that cause the formation of condensation. If condensation does form, wait until it dries completely before using the Handheld Terminal.

Product description/Intended use	
EU/EFTA member states intended for use	EU: Austria, Belgium, Denmark, Finland, France, Germany, Greece, Ireland, Italy, Luxembourg, The Netherlands, Portugal, Spain, Sweden, United Kingdom, Czech Republic, Hungary, Poland, Slovenia, Slovakia, Estonia, Latvia, Lithuania, Cyprus, Malta EFTA: Switzerland, Iceland, Lichtenstein, Norway
Member states with restrictive use	NONE
Manufacturer	CASIO COMPUTER CO.,LTD.
Brand	CASIO
Type	DT-930M50E, DT-930M51E

are tested and found to conform with the essential requirements for protection of health and the safety of the user and any other persons and Electromagnetic Compatibility, as included in following standards:

Standard	Issue date
EN 60950-1	2001
EN301 489-1 v1.4.1	2002-08
EN301 489-17 v1.2.1	2002-08

and are tested and found to conform with the essential radio test suites so that they effectively use the frequency spectrum allocated to terrestrial/space radio communication and orbital resources so to as to avoid harmful interference, as included in following standards:

Standard	Issue date
EN300 328 v1.6.1	2004-11

and therefore comply with the essential requirements and provisions of the Directive 1999/5/EC of the European Parliament and of the council of March 9, 1999 on Radio Equipment and Telecommunications Terminal Equipment and the mutual recognition of their conformity and with the provisions of Annex III (Conformity Assessment procedure referred to in article 10).

The technical documentation as required by the Conformity Assessment procedure is kept at the following address:

Company	CASIO Europe GmbH
Address, City	Bornbarch 10, D-22848 Norderstedt
Country	Germany
Phone number	+49(0)40-528-65-0
Fax number	+49(0)40-528-65-424

Products are for distribution within all member states of the EU.



- The contents of this manual are subject to change without notice.
- The term “Handheld Terminal” as used in this User’s Guide refers to the CASIO DT-930 Handheld Terminal unless otherwise noted.
- CASIO COMPUTER CO., LTD. assumes no responsibility for any loss or claims by third parties which may arise from the use of this manual.
- This manual does not cover programming and the uploading of data. See the separate manuals for details of these procedures.

Contents

Safety Precautions	E-3
Introduction	E-12
Handling Precautions	E-12
Unpacking	E-16
Available Models and Options	E-17
General Guide	E-19
Power Supply	E-20
Loading and Removing the AA (LR6)-size alkaline batteries ...	E-21
Loading and Removing the Lithium-ion Battery Pack	E-22
Replacing the Backup Lithium Battery	E-23
About the LCD Screen	E-25
Attaching the Wrist Strap	E-26
To attach the wrist strap	E-26
Keys and Their Functions	E-27
Using the Bar Code Reader	E-28
Performing a Bar Code Read Operation	E-28
Adjusting the Laser Beam Width	E-30
Communications	E-32
IR Communication	E-32
Bluetooth® Communication	E-33
Specifications	E-34
Lithium-Ion Battery Pack (DT-923LIB)	E-35
Using the Bridge Basic Cradle	E-36
Setting up the Bridge Basic Cradle	E-37
Connecting without Using the AC Adaptor	E-38
Mounting on a Wall	E-39
Removing the Wall Mount Unit	E-40
HA-E60IO Bridge Basic Cradle specifications	E-41

Using the Basic Cradle	E-42
General Guide	E-42
When You Are Using the Down-facing Reader Port Model ..	E-44
Setting up the Basic Cradle	E-44
Serial Connection of Multiple Basic Cradles	E-46
DIP Switch Settings	E-46
DT-960IOE Basic Cradle Specifications	E-47
Using the Satellite Cradle	E-48
General Guide	E-48
When You Are Using the Down-facing Reader Port Model ..	E-50
Setting up the Satellite Cradle	E-50
Charging the Battery Pack	E-53
Charging the Battery Pack (charging the lithium-ion battery pack separately)	E-54
Serial Connection of Multiple Satellite Cradles	E-55
DIP Switch Settings	E-56
DT-964IOE Satellite Cradle Specifications	E-57
Using the Cradle-type Battery Charger	E-58
General Guide	E-59
When You Are Using the Down-facing Reader Port Model ..	E-60
Setting up the Cradle-type Battery Charger	E-60
Charging the Battery Pack (charging the lithium-ion battery pack separately)	E-63
DT-969CHGE Cradle-type Battery Charger Specifications .	E-65
Installing Cradles and Cradle-type Battery Charger ...	E-66
To hang the cradles and charger on a wall	E-66



This mark applies in EU countries only.



CASIO Europe GmbH
Bornbarch 10, D-22848
Norderstedt, Germany

Unpacking

When unpacking the Handheld Terminal (either DT-930M50E or DT-930M51E), check carefully that all of the items shown below are included. If anything is missing or damaged, contact your original dealer or your nearest CASIO Service Provider.

- **Handheld Terminal (down-facing reader port)**



DT-930 M50E

- **AA (LR6)-size alkaline batteries**

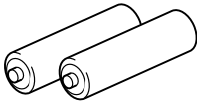

- **Wrist Strap**

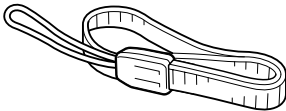

- **Desktop guides L and R for desktop configuration**

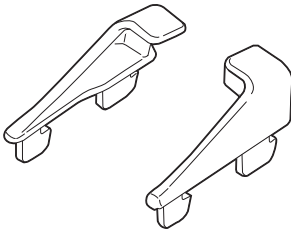

- **(forward-facing reader port)**



DT-930 M51E

- **Back-up battery (lithium)**



- **User's Guide (this guide)**

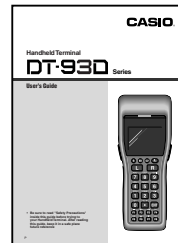

- **Wall mount guides L and R for wall mount configuration**

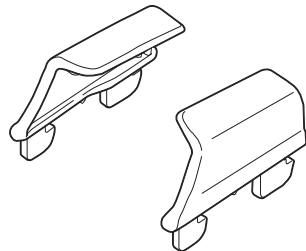

* Be sure to remove the original guides come installed on Basic Cradle, Satellite Cradle and Cradle-type battery Charger prior to the use with DT-930, and then install either one of the new guides accompanied in the package, the desktop guides for desktop configuration or the wall mount guides for wall mount configuration.

Available Models and Options

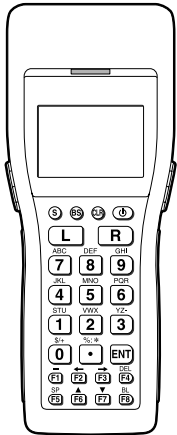

DT-930 M50E



DT-930 M51E

Options

Bridge Basic Cradle

HA-E60IO

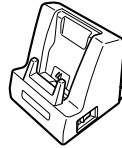

Basic Cradle

DT-960IOE

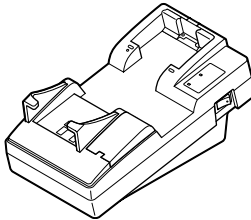

Satellite Cradle

DT-964IOE

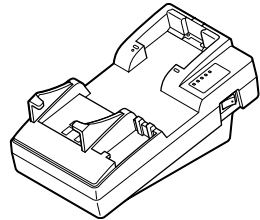

Cradle-type Battery Charger

DT-969CHGE

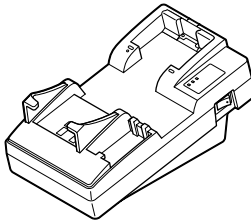

Lithium-ion Battery Pack

DT-923LIB

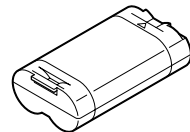

Cables

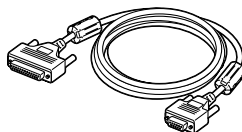

Wall Mount Unit for Bridge Basic Cradle

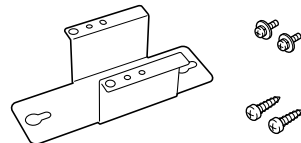

AC Adaptor for Bridge Basic Cradle

AD-S15050AE

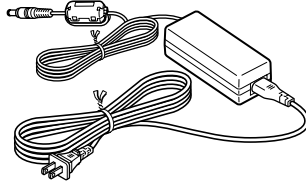
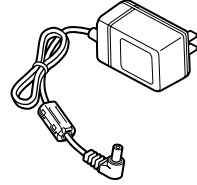
**AC Adaptor for Basic Cradle**DT-9020 ADP-GS
DT-9020ADP-US**AC adaptor for Satellite Cradle**

AD-S42120AE

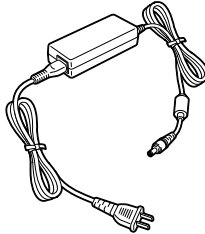
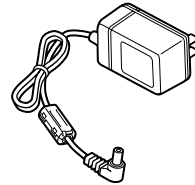
**AC adaptor for Cradle-type Battery Charger**DT-9020 ADP-GS
DT-9020ADP-US

RS-232C cable	DT-782RSC	Cross-cable for Basic Cradle	14Pin-25Pin (Male)
RS-232C cable	DT-783RSC	Cross-cable for Basic Cradle	14Pin-25Pin (female)
RS-232C cable	DT-787AX	Cross-cable for Basic Cradle	14Pin-9Pin (female)
RS-232C cable	DT-881RSC	Straight cable for Satellite Cradle	For modem connection
RS-232C cable	DT-882RSC	Cross-cable for connecting Satellite Cradle to personal computer	25Pin (male)
RS-232C cable	DT-883RSC	Cross-cable for connecting Satellite Cradle to personal computer	25Pin (female)
RS-232C cable	DT-887AX/AXA	Cross-cable for connecting Satellite Cradle to personal computer	9Pin (female)
RS-485 cable	DT-788RSC	6-6 pin modular cable or daisy-chaining Basic Cradle	
RS-422 cable	DT-888RSC	For daisy-chaining Satellite Cradle	
USB Cable	DT-380USB	Bridge Basic Cradle to personal computer	

General Guide

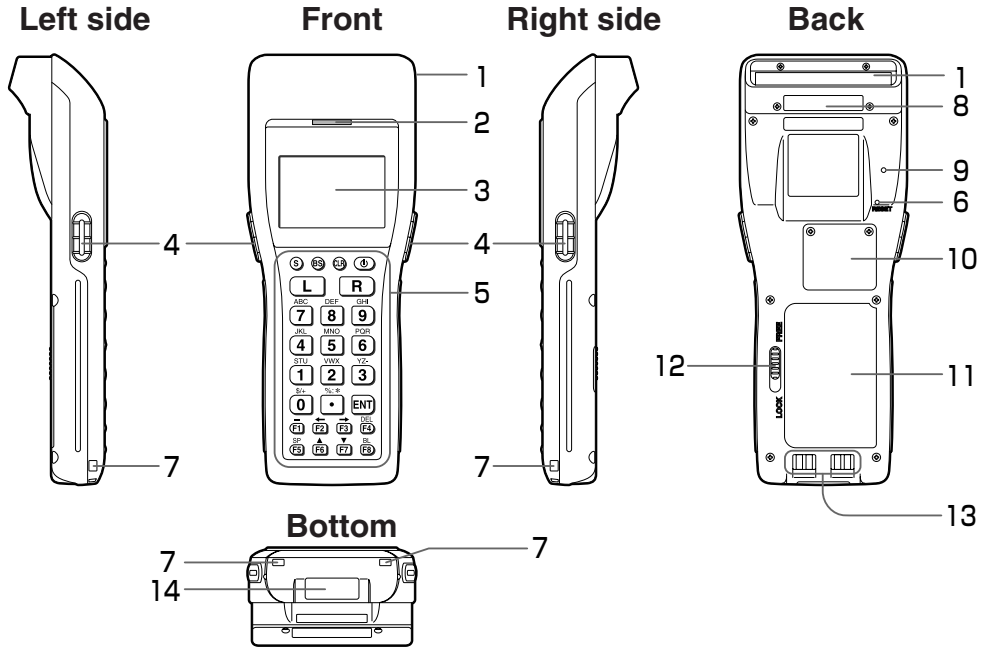

1	Reader port	Emits a laser for bar code reading.
2	Read indicator	Indicates the status of the read operation: green for a successful read, red when the read is no good.
3	LCD screen	Displays various data when a program is being run.
4	Trigger keys	Executes the bar code read operation.
5	Stroke keys	A total of 26 keys are provided to turn power ON and OFF and for other operations.
6	Reset switch (inside the hole)	Use a paper clip or other thin object to press the RESET switch located inside the hole.
7	Wrist strap hook	Used to install the wrist strap.
8	Laser warning label	Class 2 laser warning label.
9	Buzzer	Outputs operation confirmation tones. Take care to avoid blocking the buzzer holes and reducing output sound volume. Never insert any thin, pointed object into the buzzer holes. Doing so can cause malfunction.
10	Back-up battery compartment	Holds memory backup lithium battery.
11	Main battery compartment	Holds main batteries.
12	Main battery compartment lock	Locks the main battery compartment cover in place. Handheld Terminal power is automatically cut if the cover is removed.
13	Power Contacts	These terminals are used to supply power from either Bridge Basic Cradle, Basic Cradle, Satellite Cradle, or Cradle-type Battery Charger.
14	IR port	This port is for IR communication with another DT-930 unit or with one of the optional cradles.

Power Supply

The Handheld Terminal has both operating power supply provided by either two AA (LR6)-size alkaline batteries or lithium-ion battery pack, and memory backup power supply provided by lithium battery. In this manual, the words "main battery" refer to both alkaline batteries and the lithium-ion battery pack, unless otherwise noted.

Low main battery power is indicated when the low voltage message appears on the LCD screen. Replace the main battery or charge the battery pack as soon as possible after the low voltage message appears.

[Caution]

■ For Important Data



- **Never remove both the main battery and backup battery at the same time. Doing so causes all program settings and data in Handheld Terminal memory to be lost or changed. Data cannot be recovered once it is lost or corrupted. Be sure to make back-up copies of all important data. One way to do this is to use one of the optional cradles to transfer data to a computer.**

Important!

- **Never remove the main battery from the Handheld Terminal while the power is turned ON. Doing so can cause data in Handheld Terminal memory to be lost. Before you remove the battery, be sure to turn the Handheld Terminal OFF.**
- **Use only two AA (LR6)-size alkaline batteries or the dedicated lithium-ion battery pack.**
- **The lithium-ion battery pack discharges naturally during its transportation from the factory to an end-user. Be sure to charge the battery pack before you use it for the first time.**
- **Never allow the terminals of the lithium-ion battery to become shorted. Doing so creates the danger of malfunction. Be sure to keep the battery pack in its case when transporting or storing it.**
- **Repeat charging of the lithium-ion battery pack gradually shortens its ability to recharge. If you find that a fully charged battery pack provides only little operation time, it probably means you need a new battery pack.**
- **Whenever you do not plan to use the Handheld Terminal for a long time, load two new alkaline batteries or a fully charged battery pack into the Handheld Terminal to protect against power failure during non-use. Also, load new batteries or a fully charged battery pack before using the Handheld Terminal after a long period of non-use.**
- **If the battery pack has been left over unused for a long period of time, the capacity remained decreases due to spontaneous discharge or chemical decomposition by the battery pack itself. If the battery pack fails to hold its operating duration after it has been fully charged, replace it with a new one. The battery pack may reach the end of its service life.**

Loading and Removing the AA (LR6)-size alkaline batteries

Important! When you load the AA (LR6)-size alkaline batteries, make sure that their positive (+) and negative (-) ends are facing the correct directions.

Loading the alkaline batteries

1 Slide the main battery compartment cover lock to the FREE position and remove the cover.

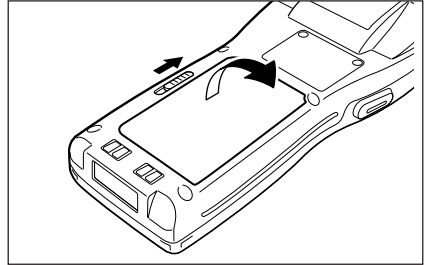

2 Load two new AA (LR6)-size alkaline batteries into the main battery compartment, making sure that they face the directions shown in the figure.

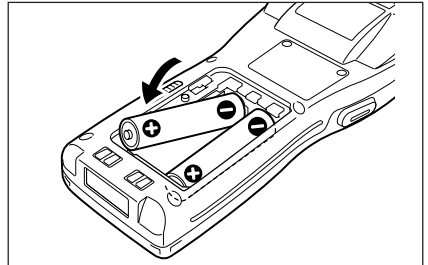

3 Attach the battery compartment cover to the Handheld Terminal and slide the main battery compartment cover lock to the LOCK position.

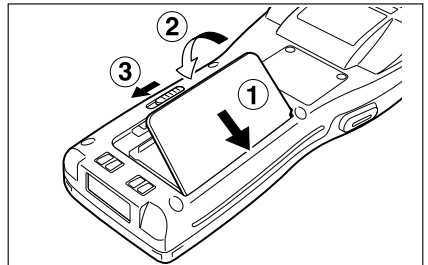

Removing the alkaline batteries

Remove the alkaline batteries following the loading procedure in reverse.
Be sure to turn the Handheld Terminal OFF before you do this.

Loading and Removing the Lithium-ion Battery Pack

Loading the Lithium-ion Battery Pack

- 1** Slide the main battery compartment cover lock to the FREE position and remove the cover.

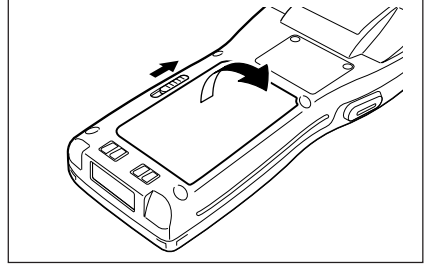

- 2** Load a lithium-ion battery pack into the main battery compartment in the direction shown in the figure. Load the battery while sliding it in with the ▲ mark on the lithium-ion battery pack aligned with the ▼ mark in the main battery compartment.

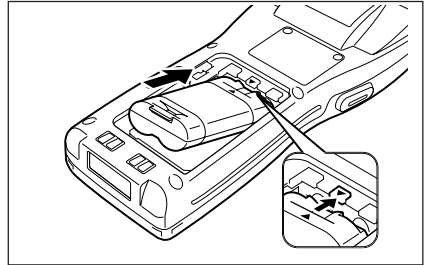

- 3** Attach the battery compartment cover to the Handheld Terminal and slide the main battery compartment cover lock to the LOCK position.

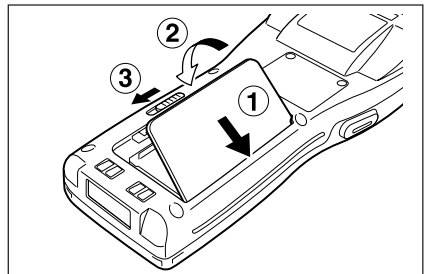

Removing the Lithium-ion Battery Pack

Remove the lithium-ion battery pack following the loading procedure in reverse. **Be sure to turn the Handheld Terminal OFF before you do this.**

Replacing the Backup Lithium Battery

When the backup lithium battery low voltage message appears on the LCD screen, immediately replace the backup battery (lithium). Use a CR2032 lithium battery as the replacement battery. Be sure to turn the Handheld Terminal OFF before you do this.

[Caution]

■ For Important Data



- When you remove the backup battery with the main battery removed or in a low-power state, data may be lost or may change. Data cannot be recovered once it is lost or corrupted. Be sure to make back-up copies of all important data. One way to do this is to use one of the optional cradles to transfer data to a computer.

Important! • Make sure that the positive (+) and negative (–) ends of the battery are facing the correct directions.

- 1** Use a screwdriver to rotate the screw that secures the backup battery holder in place counterclockwise to loosen it.

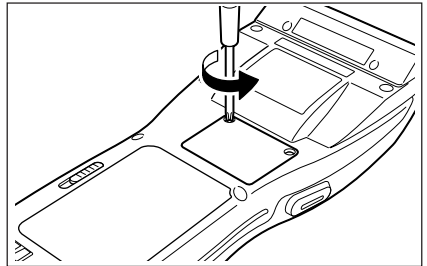

- 2** Open the backup battery compartment cover.

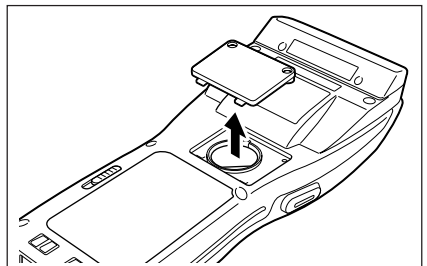

- 3** Carefully wipe the backup battery (lithium battery) with a dry cloth before inserting it with the plus (+) side up as shown in the diagram.

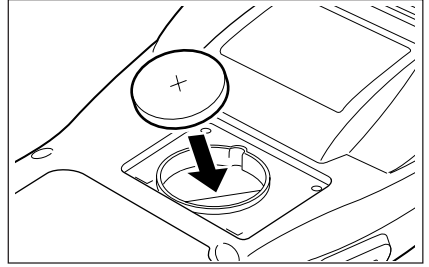

- 4** Push the lithium battery in the direction shown by the arrow to hook it.

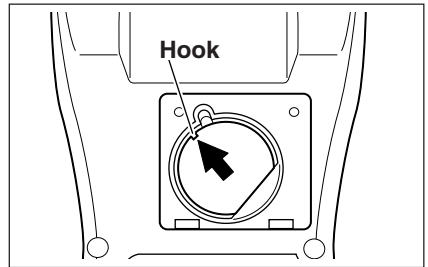

- 5** Close the backup battery cover and tighten the screws.

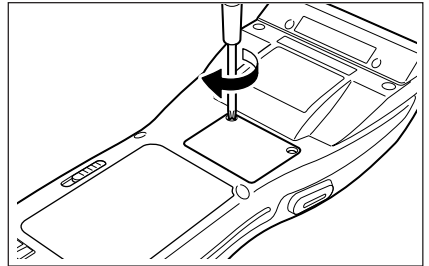

Removing the battery

- 1** Open the backup battery cover and use a ballpoint pen or other sharp object to remove the backup battery (lithium battery).
- 2** Close the backup battery cover and tighten the screws.

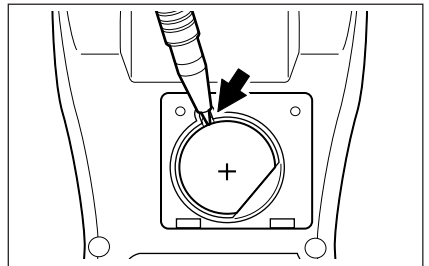

■ About the LCD Screen

The LCD screen of the Handheld Terminal shows program settings, operational procedures, calculation results and other information.

- **Display Area**

64 dots (V) x 128 dots (H)

- **Display Characters**

6-dot, 8-dot and 10-dot mode

Reduced ANK 21 columns x 10 lines, 16 columns x 8 lines, 12 columns x 6 lines

ANK 21 columns x 5 lines, 16 columns x 4 lines, 12 columns x 3 lines

- **Character Types**

Alphanumeric, symbols

- **Text Effects**

Bolding, highlighting, and other effects can be used with alphanumeric and symbols.

Built-in Clock

The Handheld Terminal has a built-in clock, so programs can be written to perform operations at certain times.

- **Example Display**

2006 / 1 / 11

□ □ □

Year Month Day

14 : 25

□ □

Hour Minute

■ Attaching the Wrist Strap

The wrist strap protects the Handheld Terminal from being damaged as a result of it being dropped by mistake during movement.

Follow the procedure below to attach the wrist strap.

To attach the wrist strap

- 1 Pass the thin end of the wrist strap through the metal hand strap mount (two possible locations) on the bottom side of the Handheld Terminal.

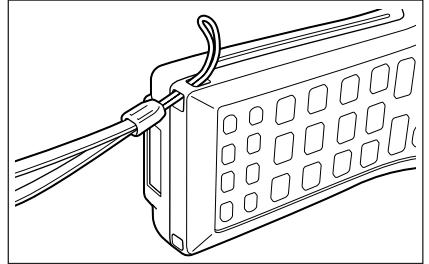

- 2 Double the strap back through its own loop, and pull it tight.

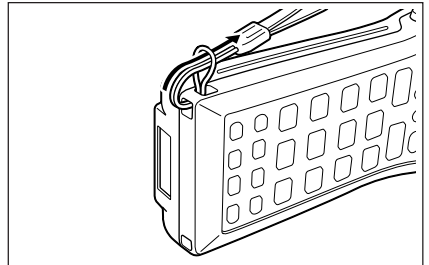

Important! • Never swing the Handheld Terminal around by its wrist strap.

Keys and Their Functions

Keys available on the Handheld Terminal and their functions are as follows.

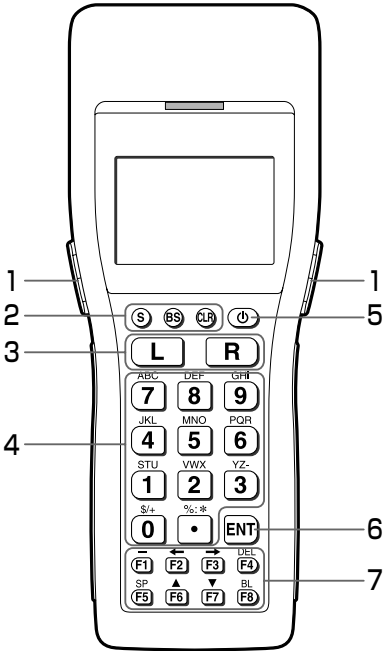

1 Trigger keys

Trigger a bar code read operation.

2 Control keys

CLR key: Cancels input.

BS key: Backspaces and deletes one character.

S key: Switches between the character input mode and the number input mode.

[S] lit on the LCD screen indicates the character input mode. When [S] is not lit, the Handheld Terminal is in the number input mode.

3 Multi-function (L/R) keys

Keys that can be assigned any function.

4 10-key pad

The function of these keys depends on whether the Handheld Terminal is in the character input mode or the number input mode.

Character input mode: Input alphanumeric and symbols.

Number input mode: Inputs the numbers 0 to 9 and the decimal point.

5 Power key

Turns power ON and OFF.

6 Enter key

Registers input.

7 Function keys

Keys that can be assigned any function except for the trigger key function. The following are the initial functions assigned to these keys.

F1 (-): Inputs the minus (-) sign.

F2 (←): Moves the cursor left.

F3 (→): Moves the cursor right.

F4 (DEL): Deletes a character.

F5 (SP): Inputs a space.

F6 (▲): Increases display contrast.

F7 (▼): Decreases display contrast.

F8 (BL): Turns the display backlight and the key lights ON and OFF.

Using the Bar Code Reader

Performing a Bar Code Read Operation

- 1 Press the [PW] key to turn power on. Hold the Handheld Terminal close to the bar code and press the trigger key.

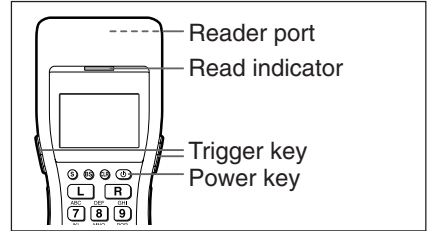

- 2 The reader port emits a laser to read the bar code. The read indicator lights green when the read is successful.

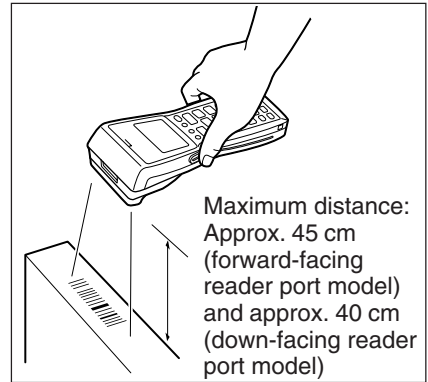

Important!

- If you have problems with the read operation, change the angle between the label and Handheld Terminal or move closer and then try again.
- If the bar code is wider than the width of the Handheld Terminal's reader port, try moving the Handheld Terminal a bit farther away from the bar code.
- The Handheld Terminal should be able to read a bar code from the maximum distance of 45 centimeters on the forward-facing reader port model and about 40 centimeters on the down-facing reader port model under the following conditions.

Ambient Light: 500~900 lux (fluorescent)

PCS: 0.9 min.

Minimum Bar Width: 1.0 mm CODE-39

ITF (extended version)

- Wavelength: 650 nm
Maximum output: 1.0 mW

CAUTION

Use of controls or adjustments or performance of procedures other than those specified herein may result in hazardous radiation exposure.



EXPLANATORY LABEL

When reading a small bar code, decrease the distance between the Handheld Terminal and the bar code. For larger bar codes, position the Handheld Terminal so that the bar code fits into the laser beam.

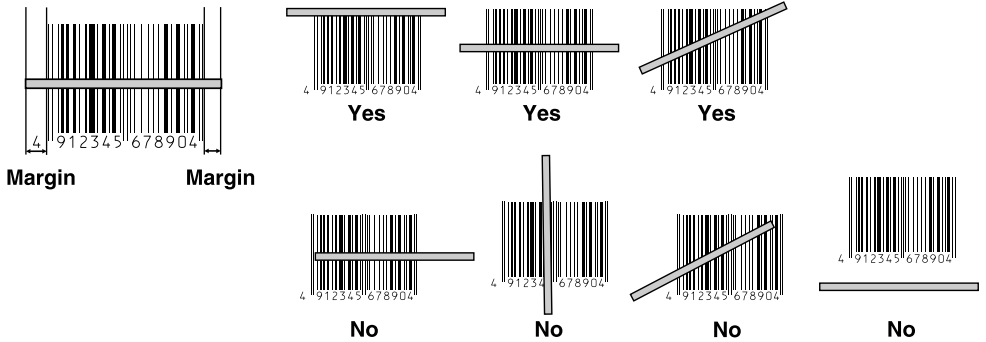

Warning!

Laser Beam



● Never look directly into the laser beam. Doing so can cause serious eye damage.

Sample Bar Codes

EAN (Standard)



EAN (Abbreviated)



NW-7



CODE39



UPC



CODE128



Adjusting the Laser Beam Width

The width of the laser beam emitted from the Handheld Terminal can be adjusted to match the width of the bar code that is being read.

When you switch the laser beam width, you must set the beam's reference point beforehand.

1 Turn the Handheld Terminal ON with the **[S]** and **[•]** keys held down to start up the system menu.

2 Press the following keys in order to start up laser beam adjustment:

- 2** Mode Set
- 3** Bar Code
- 4** Laser Beam Adjustment

3 Press the trigger key to emit the laser beam, and align the laser beam with the beam width adjustment bar code.

* Align the laser beam with the fine bars on both sides of the adjustment bar code.

(Example)

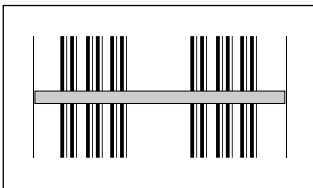

After first making sure that the laser beam is emitted at the correct position, hold down the trigger key for at least one second.

Laser beam adjustment is completed when you release the trigger key.

Startup Screen

OBR CALIBRATION

**PLEASE PUSH
TRG KEY**

**TRG :START
CLR :EXIT**

Adjustment Screen

OBR CALIBRATION

EXECUTING.....

TRG :STOP

Calibration Completed Screen

OBR CALIBRATION

FINISHED

***COMPLETE**

**TRG :RETRY
CLR :EXIT**

Beam Width Adjustment Bar Code

For down-facing reader port model



For forward-facing reader port model

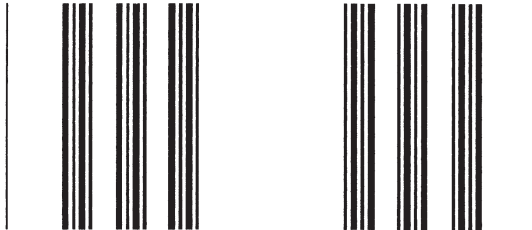

[Handling Precautions]

- The Handheld Terminal is shipped with the laser beam width already adjusted. So, the laser beam width need not be adjusted. Adjustment is necessary only when the laser beam does not switch to the correct position when the beam width is switched.
 - * Adjustment results are stored in memory.
 - * Factory settings are resumed if the Handheld Terminal is reset or all installed batteries are removed causing memory backup not to be performed.
- If adjustment is not successful, an error message is displayed. If this happens, retry adjustment.

IR Communication

Application software and input data can be transferred between two DT-930 units using the infrared ports on the bottom of the units.

Position the two DT-930 units so they will not accidentally move during communication.

The orientation of the two units depends on the type of communication you plan to perform.

- Conformed IrDA Version 1.1:
0 (contact) to 30 centimeters or less enables communication

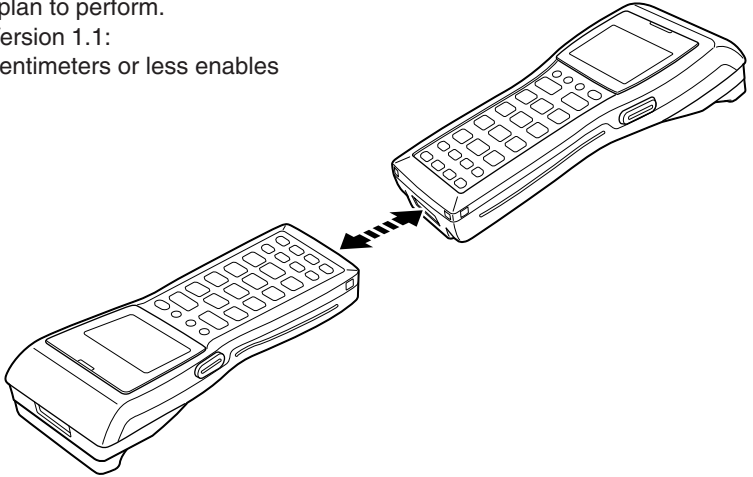

Bluetooth® Communication

The Bluetooth® interface can be used to transfer data to and from a Bluetooth® compatible printer.

Data can be transferred if the Handheld Terminal is located within three meters of the target device (and nothing is blocking the signal).

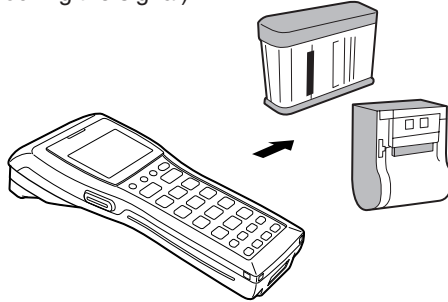

Important! Observe the following precautions to help ensure that Bluetooth communication is successful.

- Make sure the Handheld Terminal is visible from and within about 3 meters of the other Bluetooth® devices. The possible communication distance may be shorter depending on the surrounding environment (such as obstructions).
- Make sure there is at least two meters (6' 7") between the Handheld Terminal and other equipment (electrical appliances, audio-visual equipment, OA equipment, and digital cordless telephones, facsimile machines, etc.). (Take special care with microwave ovens. Allow at least three meters (9' 10 3/4") between the Handheld Terminals in wireless operation and a microwave oven.) When approaching such a device when its power is turned on, proper communication may prove impossible while this may also cause interference with TV and radio reception (images produced by certain UHF and broadcast satellite channels may become blurry).
- Normal communication may not be possible in an area near a broadcast transmitter or wireless transmitter. If this happens, move to a different location. Normal communication may not be possible in areas exposed to strong radio waves.
- RF Wireless LAN Interference
Because Bluetooth® and RF wireless LAN use the same frequency band (2.4GHz), radio interference can occur if there is a wireless LAN device nearby. This can result in lower communication speeds, or even make it impossible to establish a connection. If this happens, try the following countermeasures.
 - Move at least 10 meters (32' 10 3/4") away from the wireless LAN device.
 - If you cannot keep the distance at least 10 meters (32' 10 3/4") or more between the Handheld Terminal and a wireless LAN device, turn off the power of either the Handheld terminal or the wireless LAN device.

Specifications

• General

CPU: 32-bit RISC Type
Memory: RAM : 4MB (User area 1.6 MB)
FROM : 16MB (User area 12.5 MB)

• Display

Type: STN LCD with phase correction film
Capacity: 128 x 64 dots
Display contrast: Manually adjustable
Backlight: LED

• Laser Scanner

Readable Symbologies:
EAN, JAN, UPC, NW-7, CODE39, ITF, CODE93, CODE128, MSI,
Industrial 2 of 5, IATA
Maximum Non-contact Distance:
Approx. 450 mm max.
(DT-930M51E)
Approx. 400 mm max.
(DT-930M50E)

• Input

Stroke Keys: 26

• Infrared Communications

Interface: Conforms to IrDA Ver. 1.1, original
Control Protocol: Half-duplex
Synchronization: Asynchronous, frame synchronization
Speed: 2,400 to 115,200 bps, 4 Mbps
Communication Range:
Conforms to IrDA Version 1.1: 0 (contact) to 30 centimeters or less
Original Communication: Contact

• Bluetooth® Communications

Interface: Bluetooth® Specification Ver 1.2
Communication Range:
Approx. 3 meters (varies according to signal strength and
environment)
Output: Maximum 3 dBm (Power Class 2)

• Power Supply

Main:	Two AA (LR6)-size alkaline dry cells or one lithium-ion battery pack
	Alkaline Battery life:
	- Approx. 200 hours (using a new set of AA(LR6)-size alkaline batteries, at normal temperature, and in scanning bar code twice per 10 seconds)
	- Approx. 175 hours (using a new set of AA (LR6)-size alkaline batteries at normal temperature at a key standby/calculation/read operation ratio of 20:1:1)
	- Approx. 50 hours (using a new fully charged battery pack, at normal temperature, and in scanning bar code twice per 10 seconds)
	- Approx. 30 hours (using a new fully charged lithium-ion battery pack at normal temperature at a key standby/calculation/read operation ratio of 20:1:1)
Backup:	One CR2032 lithium battery
Battery life:	Approx. one month (when only the backup battery is supplying backup power)

• Dimensions and Weight

Dimensions:	DT-930M51E
	Approx. 69 (W) x 173 (D) x 31.6 (H) <display> Don't include protrusions
	Approx. 57.4 (W) x 173 (D) x 21.9 (H) <grip> Don't include protrusions
	DT-930M50E
	Approx. 69 (W) x 180 (D) x 40.2 (H) <display> Don't include protrusions
	Approx. 57.4 (W) x 180 (D) x 21.9 (H) <grip> Don't include protrusions
Weight:	Approx. 210 g (DT-930M51E)
	Approx. 225 g (DT-930M50E)
	(When AA (LR6)-size alkaline batteries are inserted)

• Operating Environment

Operating temperature:	-20 to 50° C
Operating humidity:	10% to 80% RH
Dust and Water Splash Proof:	
	Conforms to JIS waterproofing and IEC529 IP54
Drop Durability:	180 cm
Clock functions:	Year, month, date, hour, minute, fully automatic calendar and alarm
Vibration function:	Can be used if the software is set.

Lithium-Ion Battery Pack (DT-923LIB)

Power Supply:	Rated Capacitance: 540 mAh
Rated Voltage:	3.6 V
Dimensions:	Approx. 29 (W) x 50.2 (D) x 14.5 (H) mm
Weight:	Approx. 20 g

Using the Bridge Basic Cradle

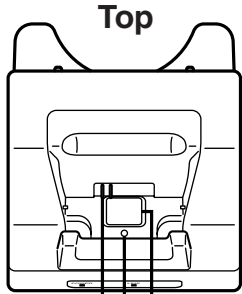

3 5 4

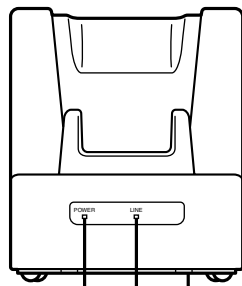

1 2 10

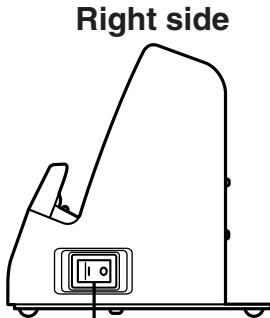

6

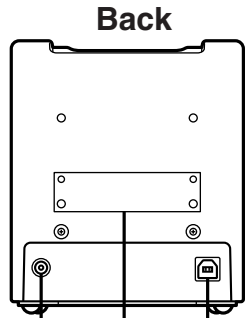

7 9 8

1 LED power indicator	Indicates the charge status of the battery and whether the DT-930 is mounted. Off: Power OFF Lit Green: Power is ON and the DT-930 is correctly mounted. Lit Red: Power is ON and the DT-930 is not correctly mounted.
2 USB connection status	Indicates that the USB connection is normal. Off: USB connection is not normal. Lit Green: USB connection is normal.
3 Power supply terminal	Supplies power to the DT-930. (For use with AC adaptor only)
4 Infrared Interface	Non-contact infrared interface. Used to communicate with the DT-930.
5 Terminal detection switch	Detects whether or not the DT-930 is mounted correctly.
6 Power switch	Turns power ON and OFF.
7 AC adaptor jack	For connection of the AC adaptor (AD-S15050AE) to supply power.
8 USB interface	For connection to a PC and uploading/downloading of system data and file data. Also to draw power through the connection to the PC. A special driver needs to be installed in the PC before connecting the Handheld Terminal to the PC.
9 Wall mount unit attachment	Install the wall-mount unit with the wall mounting screws.
10 Desktop unit	Stand for using the Handheld Terminal on a desktop. Remove it when mounting the cradle to a wall.

Setting up the Bridge Basic Cradle

1 Make sure that the Bridge Basic Cradle's power switch is turned off and then plug the optional AC adaptor (AD-S15050AE) into the AC adaptor jack on the back of the Bridge Basic Cradle.

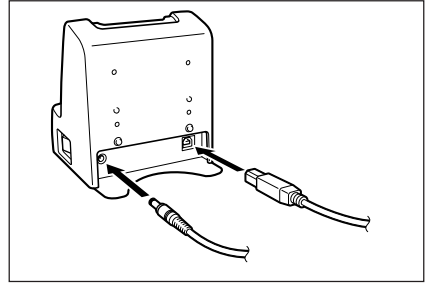

2 Connect the power cord to the AC adaptor before connecting the power cord to the electrical outlet.

3 Connect the USB cable (DT-380USB) to the USB port on the back of the Bridge Basic Cradle and then connect it to the personal computer.

4 Line up the infrared interface on the bottom of the DT-930 and the infrared interface on the Bridge Basic Cradle to mount the DT-930.

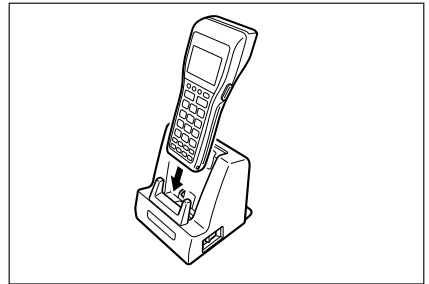

5 Turn on the power switch. The power indicator LED on the front of the Bridge Basic Cradle lights green if the DT-930 is correctly mounted.

Connecting without Using the AC Adaptor

- It is possible to draw power from the personal computer in the bus power mode. This makes it possible to operate the Bridge Basic Cradle without using the AC adaptor.
- Power is not supplied to the DT-930 when the USB connection is used to supply power. Replace the batteries to transfer data if the low voltage message is displayed on the DT-930. Also, use a personal computer that has USB connectivity that supports high-power devices.
- Some personal computers cannot provide a stable power supply, confirm whether your computer can provide a stable power supply. If it is unstable use the optional AC adaptor.

- Important!**
- **Mount the DT-930 firmly and make sure that the LED power indicator on the front of the Bridge Basic Cradle lights green. If it is not correctly mounted communication cannot be done.**
 - **Do not allow the supply contacts in the Bridge Basic Cradle to short circuit. If they short circuit it may cause a malfunction.**
 - **Do not shake or hit the Bridge Basic Cradle or DT-930 during communications over the USB interface. Doing so may interrupt communications.**
 - **The infrared communication function uses a high-sensitivity communication element.**
To ensure proper communication, avoid using devices that generate radio waves (for example; cell phones, etc.) in the vicinity of the DT-930 while communication is in progress.
Move these devices away from the DT-930 to use them (cell phones should be moved more than 30 cm away).
 - **The cradle does not have the capability of charging battery pack installed in DT-930.**
 - **The cradle (HA-E60IO) is not operable with DT-900.**

Mounting on a Wall

- 1** Remove the screws on the bottom of the desktop unit to remove it.

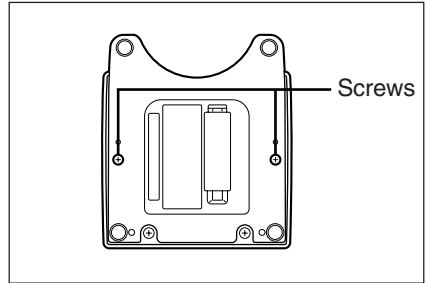

- 2** Attach the wall mount unit and tighten the screws for the wall mount unit.

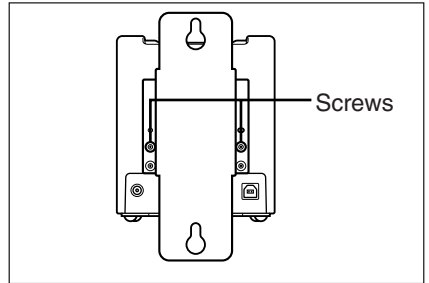

- 3** Insert the screw provided into the location where the hole on the top of the wall mount unit is to be fixed.
Do not screw the screw all the way in. Leave about 2 mm between the wall and the head of the screw.

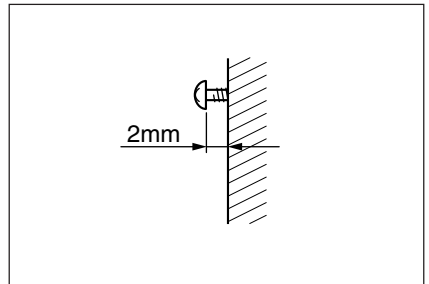

- 4** Hang the wall mount unit from the screw through the hole on its top.

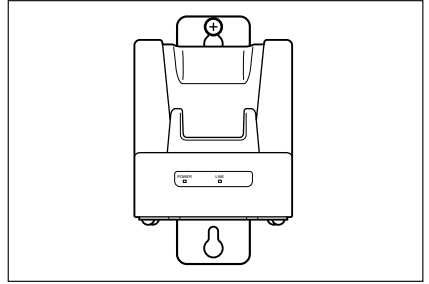

- 5** Insert the screw provided into the top part of the lower hole of the wall mount unit.

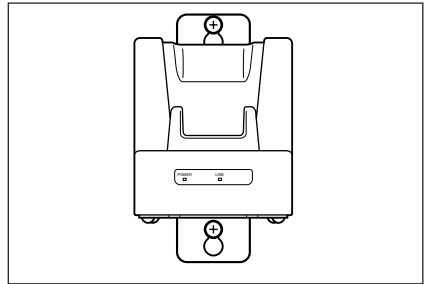

- 6** Tighten both the upper and lower screws.

Removing the Wall Mount Unit

- 1** Loosen both the upper and lower screws.
- 2** Slide the wall mount unit up to remove it.

Important! • Check the tightness of the screws after mounting the Bridge Basic Cradle to the wall.

HA-E60IO Bridge Basic Cradle specifications

1. Infrared

Interface:	Infrared interface
Standard:	Conforms to IrDA Ver 1.1
Synchronization:	Asynchronous, frame synchronizing
Speed:	4 Mbps (MAX)

2. USB

Standard:	Conforms to USB Ver 1.1
Speed:	12 Mbps (MAX)

3. Power supply

Power Source:	AC adaptor (AD-S15050AE) USB bus power
Rated input:	When using the AC adaptor: 1.0 A (max.) When using USB bus power: 0.4 A (max.)

4. AC adaptor

Model no.:	AD-S15050AE
Input:	AC 100 V to 240 V, 50/60 Hz, 0.36 A to 0.2 A
Output:	DC 5 V, 3.0 A

5. Dimensions and Weight

Dimensions

Desktop:	Approx. 110 (W) x 125 (D) x 128 (H) mm
Wall mount:	Approx. 110 (W) x 148 (D) x 154 (H) mm

Weight

Desktop:	Approx. 510 g
Wall mounted:	Approx. 590 g

6. Operating environment

Operating temperature:	0 to 40°C
Operating humidity:	30 to 80% RH (without condensation)

Using the Basic Cradle

Basic Cradle (DT-960IOE) makes it possible to upload system data and file data between the Handheld Terminal and a personal computer.

You can use optional 6-6 pin Modular Cables (DT-788RSC) to connect up to 16 Basic Cradles. Use the RS-232C cable (DT-782RSC/DT-783RSC/DT-787AX) for connecting the Cradle to a personal computer. The Basic Cradle can be located on a desk or table top, or mounted on a wall. When the Basic Cradle is mounted on a wall, be sure to use the wall mount unit (supplied).

General Guide

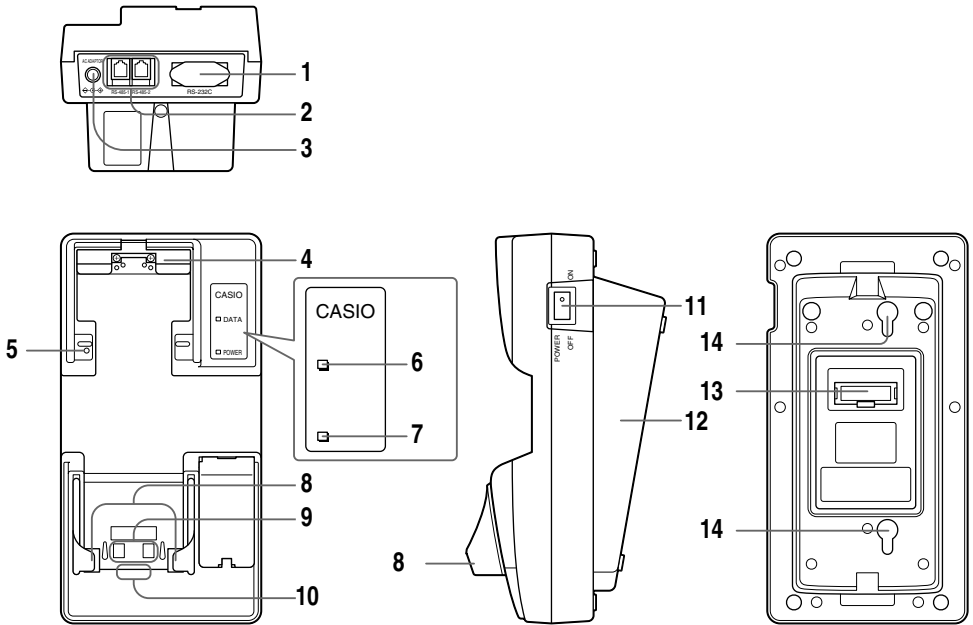

Accessories

Spacers



Wall mount guides

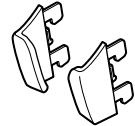

Wood screws



Wall unit screws

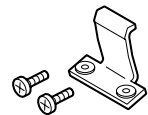

1	RS-232C Interface	For connection of a PC and uploading/downloading of system data and file data.
2	RS-485 Interface	For connection of multiple optional Basic Cradles.
3	AC adaptor jack	For connection of the dedicated AC adaptor to supply power.
4	Nose Guide	Remove this guide when you are using the down-facing reader port model.
5	Terminal detection switch	Detects whether or not the Handheld Terminal is mounted correctly on the Basic Cradle.
6	Communication indicator	Indicates the status of communication operations. Off: Not communicating Flashing Green: Communication in progress
7	Power indicator	Indicate whether power is ON or OFF, and if the Handheld Terminal is mounted. Off: Power OFF Lit Red: Power ON, Handheld Terminal not mounted Lit Green: Power ON, Handheld Terminal mounted
8	Desktop guides (L, R)	Holds down the Handheld Terminal on the Basic Cradle that is placed on a flat surface in desktop configuration.
9	Charge/Power supply terminal	Supplies power to the Handheld Terminal mounted on the Basic Cradle.
10	Infrared port	This port provides contact-less infrared communication capability with the Handheld Terminal.
11	Power switch	Turns power ON and OFF.
12	Base	Reverse the position of the base when wall-mounting the Basic Cradle.
13	DIP switches	Use these switches to set the operational configuration of the Basic Cradle.
14	Wall mounting holes	Use these holes to attach the Basic Cradle to a hook on a wall.

When You Are Using the Down-facing Reader Port Model

When you are using a down-facing reader port model, remove the nose guide before use. To remove the nose guide, remove the two screws using a screwdriver.

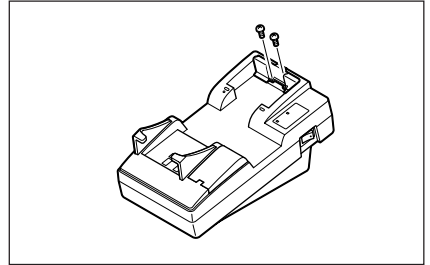

Setting up the Basic Cradle

Use only the dedicated AC adaptor for Basic Cradle to connect to an electrical outlet. Be sure to connect the AC adaptor and then turn on the power on the Basic Cradle before performing any communication with the Handheld Terminal. Power is supplied to the Handheld Terminal by the cradle.

- 1 Remove the two desktop guides, L and R, installed on the cradle by sliding them toward the rear side as shown in the illustration.

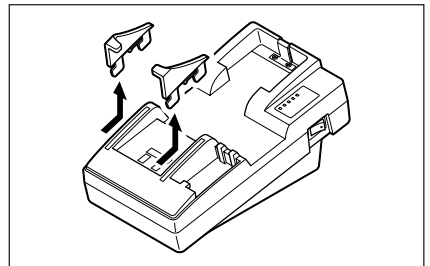

- 2 Insert the desktop guides, L and R, one at a time that were accompanied with DT-930 into each slit and then slide them toward the front side as shown in the illustration.

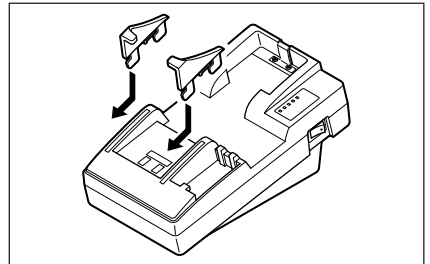

3 Plug the AC adaptor into an electrical outlet.

4 After making sure that the power switch of the Basic Cradle is in the OFF position, plug the other end of the AC adaptor into the AC terminal at the top of the Basic Cradle.

5 After making sure that the power of the Basic Cradle and personal computer is OFF, remove the cover and connect one end of the optional RS-232C cable (DT-782RSC, DT-783RSC, DT-787AX) to the RS-232C connector at the top of the Basic Cradle. Connect the other end of the cable to the computer's RS-232C connector. When the RS-232C connector is not used, attach the cover.

6 Turn on the Basic Cradle. The power indicator on the Basic Cradle lights red.

7 Attach the Handheld Terminal to the Basic Cradle, making sure their infrared ports come into close contact with each other. The color of the Basic Cradle power supply indicator changes to green when proper connection is achieved. The data communication indicator flashes green when communication starts.

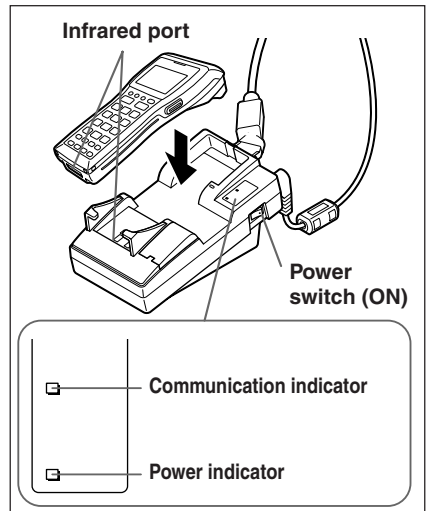
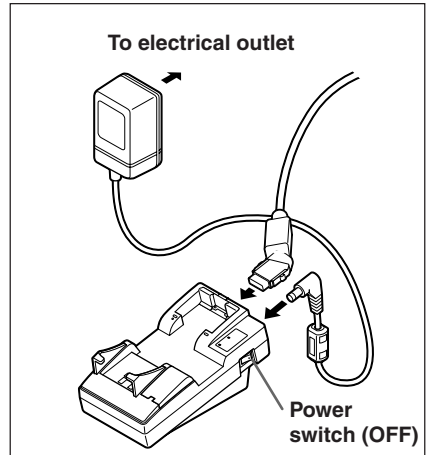

- Important!**
- **High-sensitivity communications devices are used for the IrDA communications function. Avoid using units or equipment such as a cellular phone emits radio waves during communication. To ensure uninterrupted communication, keep the Basic Cradle away from the equipment (at least 30 centimeters from a cellular phone).**
 - **“L” (for left) or “R” (for right) marking is imprinted on the back of each desktop guide and wall mount guide both accompanied with DT-930. Be sure to install the new guides properly on the Basic Cradle, the desktop guides for desktop configuration or the wall mount guides for wall mount configuration. The use of the cradle with DT-930 without replacing the original guides come installed on it with the new guides will result in either communication error or improper charging battery pack.**
 - **However, the use of the cradle with the new guides installed for DT-900 does not result in the errors.**

Serial Connection of Multiple Basic Cradles

You can use optional 6-6 pin Modular Cables (DT-788RSC) to connect up to 16 Basic Cradles in a serial configuration. This configuration makes it possible to exchange data between multiple Handheld Terminals and a personal computer.

Connections

First connect Basic Cradle RS-485-1 and then the RS-485-2 of the Basic Cradle that you want to connect to.

DIP Switch Settings

The following table shows the various settings that are available with the DIP switches located on the back of the Basic Cradle.

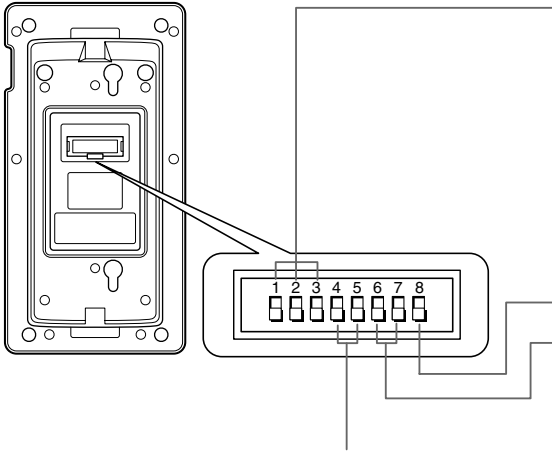
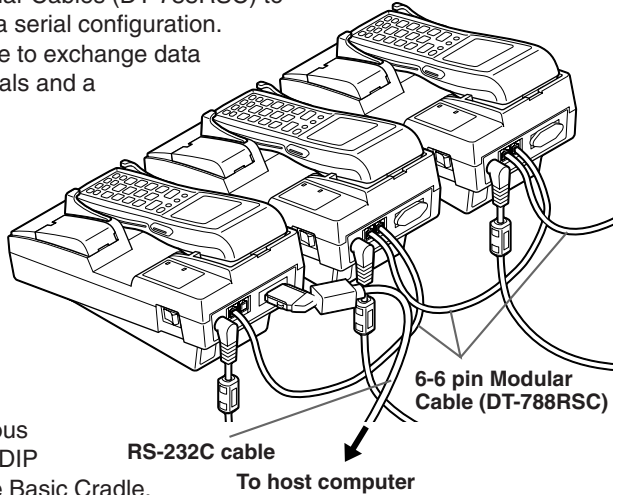

Handheld Terminal - Basic Cradle Communication Speed

	1	2	3
2,400bps	OFF	OFF	OFF
9,600bps	ON	OFF	OFF
19,200bps	OFF	ON	OFF
38,400bps	ON	ON	OFF
57,600bps	OFF	OFF	ON
115,200bps	ON	OFF	ON

Unused

Connection Type

	6	7
Host Computer Connection (no linking)	ON	ON
Intermediate Unit in Linked Chain	OFF	OFF
Terminator Unit in Linked Chain	ON	OFF

RS-232C Control Signal Setting

	4	5
RS enabled	ON	-
ER enabled	-	ON

Important! • Other settings not shown here are for special-purpose modes, and should not be used.

DT-960IOE Basic Cradle Specifications

Infrared

Interface:	Infrared
Standard:	CASIO original
Control Protocol:	Half-duplex
Synchronization:	Asynchronous
Speed:	2,400 to 115,200 bps

RS-232C

Control Protocol:	Half-duplex
Synchronization:	Asynchronous
Speed:	2,400 to 115,200 bps

RS-485

Control Protocol:	Half-duplex
Synchronization:	Asynchronous
Speed:	2,400 to 115,200 bps

Power Supply

Power Source:	AC adaptor (DT-9020ADP-GS or DT-9020ADP-US)
Power Requirements:	AC 230 V (DT-9020ADP-GS) AC 120 V (DT-9020ADP-US)
Rated Input:	DC 9.5 V, approx. 1,000 mA

Functions

- Infrared interface
- RS-232C interface
- RS-485 interface

Serial Connection

Up to 16 units

Dimensions and Weight

Desktop:	Approx. 110 (W) x 220 (D) x 100 (H) mm Approx. 400 g
Wall Mounted (with wall mount unit attached):	Approx. 110 (W) x 220 (D) x 110 (H) mm Approx. 410 g

Using the Satellite Cradle

Satellite Cradle (DT-964IOE) makes it possible to upload system data and file data between the Handheld Terminal and a personal computer. It can also be used as the charger for the lithium-ion battery pack.

Use the RS-232C cable (DT-881RSC/DT-882RSC/DT-883RSC/DT-887AX/AXA) for connecting the Satellite Cradle to a personal computer. The Satellite Cradle can be located on a desk or table top, or mounted on a wall. When the Satellite Cradle is mounted on a wall, be sure to use the wall mount unit (supplied).

General Guide

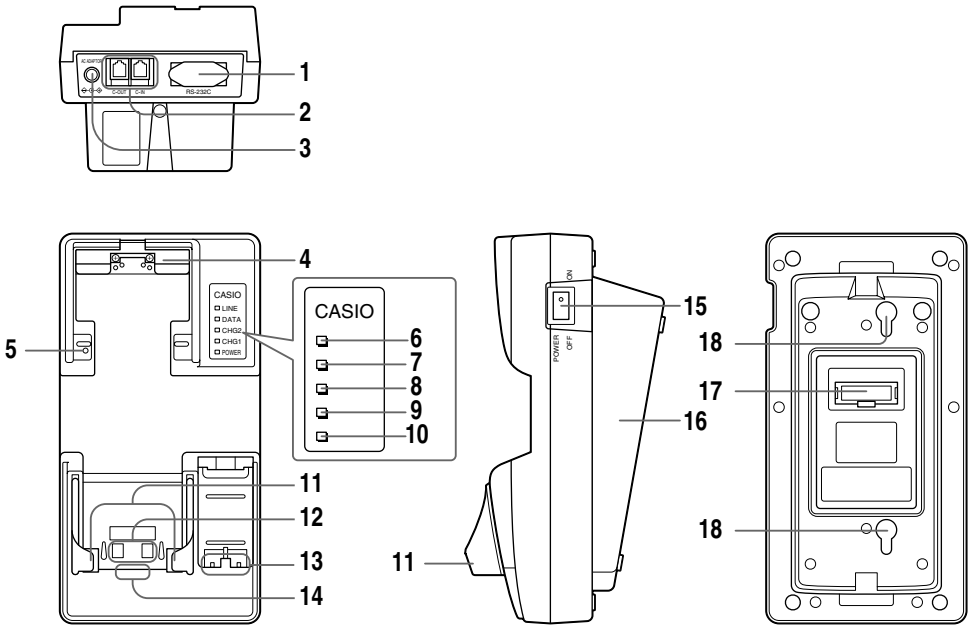

Accessories

Spacers



Wall mount guides



Wood screws



Wall unit screws

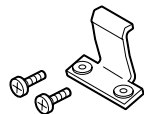

1	RS-232C Interface	For connection to a PC and uploading/downloading of system data and file data.
2	RS-422 Interface	For connection of multiple Satellite Cradles.
3	AC adaptor jack	For connection of the AC adaptor to supply power.
4	Nose Guide	Remove this guide when you are using the down-facing reader port model.
5	Terminal detection switch	Detects whether or not the Handheld Terminal is mounted correctly on the Satellite Cradle.
6	System operation indicator	Indicates whether or not system operation is normal. A system operation problem is indicated when this indicator does not light up green shortly after the Handheld Terminal is mounted onto the Satellite Cradle. Off: All Handheld Terminals mounted on the Satellite Cradle are unable to communicate, or there is a system problem. Lit Green: Normal system operation. One or more of the Handheld Terminals mounted on the Satellite Cradles are communicating.
7	Communication indicator	Indicates the status of communication operations. Off: Not communicating Flashing Green: Communication in progress Lit Red: Satellite Cradle connection problem
8	Spare battery pack charge indicator ("CHG 2")	Indicates the charge status of the spare battery pack. Off: Not charging, or a battery pack problem Lit Red: Charging (charging standing by when the battery in the Handheld Terminal is charging) Lit Green: Charging complete
9	Battery pack charge indicator ("CHG 1")	Indicates the charge status of the lithium-ion battery pack in the Handheld Terminal. Off: Not charging (e.g. lithium-ion battery not loaded in Handheld Terminal) or a battery pack problem Lit Red: Charging Lit Green: Charging complete
10	Power indicator ("READY/POWER")	Indicates whether power is ON or OFF, and if the Handheld Terminal is mounted. Off: Power OFF Lit Red: Power ON, Handheld Terminal not mounted Lit Green: Power ON, Handheld Terminal mounted
11	Desktop guides (L, R)	Holds down the Handheld Terminal on the Satellite Cradle that is placed on a flat surface in desktop configuration.
12	Charge/Power supply terminals	Supplies power to the Handheld Terminal mounted on the Satellite Cradle.
13	Battery pack charge terminals	Charges the spare battery pack separately.
14	Infrared port	This port provides IR communication capabilities with a Handheld Terminal.
15	Power switch	Turns power ON and OFF.
16	Base	Reverses the position of the base when wall-mounting the Satellite Cradle.
17	DIP switches	Use these switches to set the operational configuration of the Satellite Cradle.
18	Wall mounting holes	Use these holes to attach the Satellite Cradle to a hook on a wall.

When You Are Using the Down-facing Reader Port Model

When you are using a down-facing reader port model, remove the nose guide before use. To remove the nose guide, remove the two screws using a screwdriver.

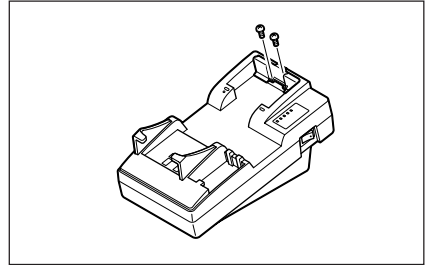

Setting up the Satellite Cradle

Use only the dedicated AC adaptor for Satellite Cradle to connect to an electrical outlet. Be sure to connect the AC adaptor and turn on Satellite Cradle power before performing any communication with the Handheld Terminal. Power is supplied to the Handheld Terminal by the Satellite Cradle.

- 1 Remove the two desktop guides, L and R, installed on the cradle by sliding them toward the rear side as shown in the illustration.

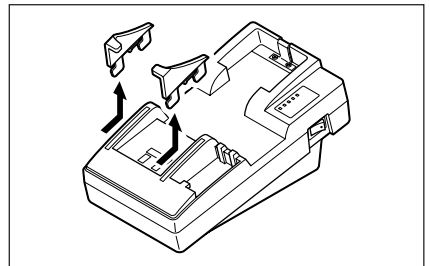

- 2 Insert the desktop guides, L and R, one at a time that were accompanied with DT-930 into each slit and then slide them toward the front side as shown in the illustration.

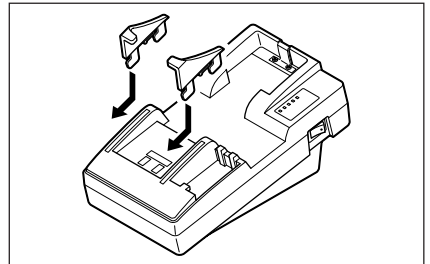

- 3** Connect the power cord to the AC adaptor before connecting the power cord to the power outlet.
- 4** After making sure that the power switch of the Satellite Cradle is in the OFF position, plug the other end of the AC adaptor into the AC terminal at the top of the Satellite Cradle.
- 5** After making sure that the power of the Satellite Cradle and personal computer is OFF, remove the cover and connect one end of the optional RS-232C cable (DT- 881RSC, DT-882RSC, DT-883RSC, DT- 887AX/AXA) to the RS-232C connector at the top of the Satellite Cradle. Connect the other end of the cable to the computer's RS- 232C connector. When the RS-232C connector is not used, attach the cover.

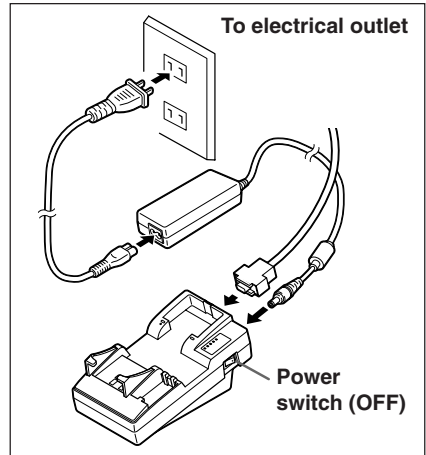

- 6** Turn on the Satellite Cradle. The power indicator on the Satellite Cradle lights red.
- 7** Attach the Handheld Terminal to the communication port, making sure that the infrared ports on its base come into close contact with each other. The color of the Satellite Cradle power indicator changes to green when a proper connection is made.
 - The system operation indicator lights green when system operation is normal and the Satellite Cradle is performing or standing by for the communication with another Handheld Terminal connected to a Satellite Cradle.
 - The communication indicator flashes green when communication starts.

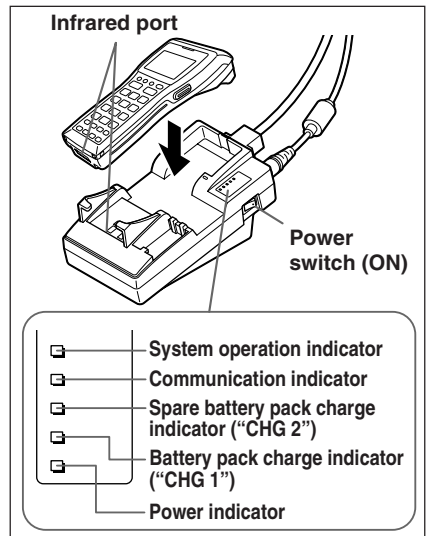

- Important!**
- **High-sensitivity communications devices are used for the IrDA communications function. Avoid using units or equipment such as a cellular phone emits radio waves during communication. To ensure uninterrupted communication, keep the Satellite Cradle away from the equipment (at least 30 centimeters from a cellular phone).**
 - **“L” (for left) or “R” (for right) marking is imprinted on the back of each desktop guide and wall mount guide both accompanied with DT-930. Be sure to install the new guides properly on the Satellite Cradle, the desktop guides for desktop configuration or the wall mount guides for wall mount configuration. The use of the cradle with DT-930 without replacing the original guides come installed on it with the new guides will result in either communication error or improper charging battery pack.**
 - **However, the use of the cradle with the new guides installed for DT-900 does not result in the errors.**

Charging the Battery Pack

The following procedure can be used only when a lithium-ion battery pack is loaded in the Handheld Terminal.

- 1 Turn on the power of the Satellite Cradle, and confirm that its power indicator lights up red.
- 2 Attach the Handheld Terminal to the Satellite Cradle, making sure that the charge terminals on the bottom of the Handheld Terminal come into contact with the charge terminals on the Satellite Cradle. The color of the Satellite Cradle power indicator changes to green when proper connection is achieved. The charge indicator ("CHG 1") lights up red when charging starts.

Battery Pack Charge Indicator ("CHG 1")

Lit Red: Charging
Lit Green: Charging complete

When the charge indicator lights red and then goes out after several seconds, this indicates a battery problem.

Charging Time

Approx. 6 hours

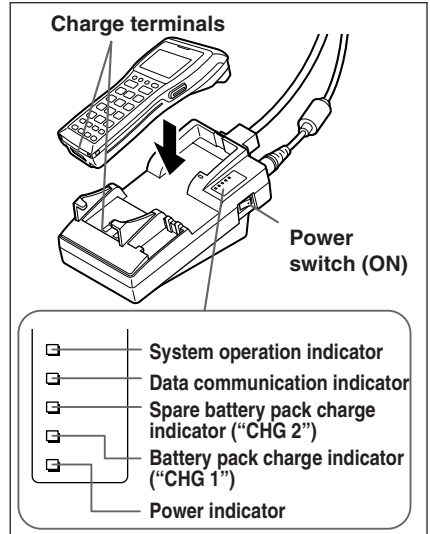

[Caution]

■ Ambient Temperature Ranges for the Battery Pack



- Temperature ranges for battery pack use in the Handheld Terminal, charging, and storage are specified below. Temperatures outside these ranges create the danger of deterioration of battery pack performance and shortening of its service life, as well as fluid leakage and heat generation.

Operating Temperature: -20°C to 50°C

Charging Temperature: 0°C to 40°C

Storage Temperature: -20°C to 60°C

Important!

- If the charge indicator does not light during charging, remove the battery pack and then re-attach it. If this does not solve the problem, it means that the battery pack is defective and needs to be replaced.
- Use only the specified battery pack.
- Battery packs naturally discharge even when they are not loaded in the Handheld Terminal. Use a battery pack as soon as possible after charging it.
- For best charging results, keep the Satellite Cradle, Handheld Terminal and battery pack contacts clean by periodically wiping them off with a cotton swab or dry cloth.

Charging the Battery Pack (charging the lithium-ion battery pack separately)

- 1 Set the power switch of the Satellite Cradle to the ON position. The power indicator of the Satellite Cradle lights red.
- 2 Load the battery pack in the spare battery compartment on the Satellite Cradle, making sure that the terminals on the side and rear of the battery pack come into close contact with the battery pack charge terminals. The battery pack charge indicator ("CHG 2") lights red, and charging is started.

Spare Battery Pack Charge Indicator ("CHG 2")

Lit Red:	Charging (charging standing by when the battery in the Handheld Terminal is charging)
Lit Green:	Charging complete

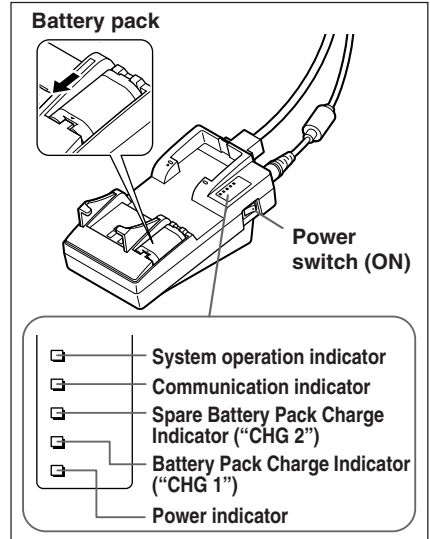

- When the battery pack charging indicator lights red and then goes out after several seconds, this indicates a battery pack problem.
- Charging of the battery in the Handheld Terminal is given precedence. Separate charging of the battery pack cannot be performed simultaneously while charging of the battery in the Handheld Terminal.

[Caution]

■ Ambient Temperature Ranges for the Battery Pack



- Temperature ranges for battery pack use in the Handheld Terminal, charging, and storage are specified below. Temperatures outside these ranges create the danger of deterioration of battery pack performance and shortening of its service life, as well as fluid leakage and heat generation.

Operating Temperature: -20°C to 50°C

Charging Temperature: 0°C to 40°C

Storage Temperature: -20°C to 60°C

Important!

- If the battery pack charge indicator does not light during charging, remove the battery pack and then re-attach it. If this does not solve the problem, it means that the battery pack is defective and needs to be replaced.
- Use only the specified battery pack.
- Battery packs naturally discharge even when they are not loaded in the Handheld Terminal. Use a battery pack as soon as possible after charging it.
- For best charging results, keep the Satellite Cradle, Handheld Terminal and battery pack contacts clean by periodically wiping them off with a cotton swab or dry cloth.

Serial Connection of Multiple Satellite Cradles

You can use optional 6-6 pin Modular Cables (DT-888RSC) to connect up to 7 Satellite Cradles in a serial configuration. This configuration makes it possible to exchange data between multiple Handheld Terminals and a personal computer via the cradles.

Connections

Connect C-OUT on the Satellite Cradle nearest the host computer to C-IN on the next Satellite Cradle that you next want to connect to.

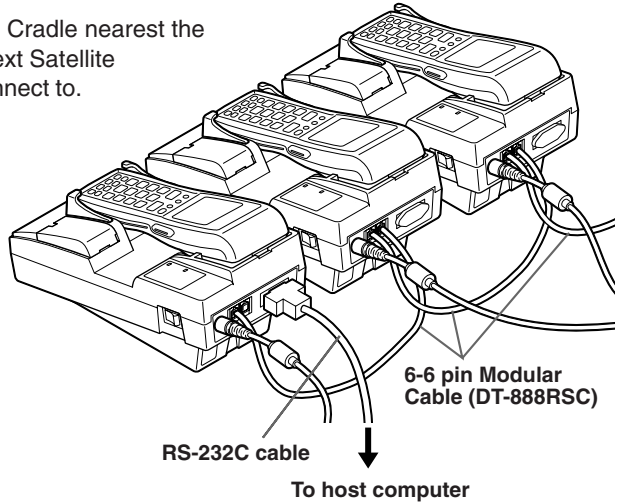

DIP Switch Settings

The following table shows the various settings that are available with the DIP switches located on the back of the Satellite Cradle.

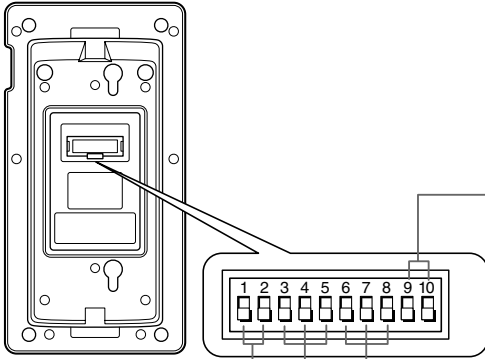

Flow Control

	9	10
Off	OFF	OFF
X ON/X OFF	ON	OFF
RS/CS	OFF	ON
Use Special Software	ON	ON

Satellite Cradle - Host Computer Communication speed

	6	7	8
2,400bps	OFF	OFF	OFF
4,800bps	ON	OFF	OFF
9,600bps	OFF	ON	OFF
19,200bps	ON	ON	OFF
38,400bps	OFF	OFF	ON
57,600bps	ON	OFF	ON
115,200bps	OFF	ON	ON

* Communication speed can be set by Handheld Terminal overrides this setting.

Connection Type

	3	4	5
Host Computer Connection	OFF	OFF	ON (No linking) OFF (Linking)
Intermediate Unit in Linked Chain	ON	OFF	OFF
Terminator Unit in Linked Chain	ON	OFF	ON

Handheld Terminal - Satellite Cradle Communication Speed

	1	2
38,400bps	OFF	OFF
115,200bps	ON	OFF

Important! • Other settings not shown here are used for special-purpose modes, and should not be used.

DT-964IOE Satellite Cradle Specifications

Infrared

Interface:	Infrared
Standard:	Conforms to IrDA Ver. 1.2 Original
Synchronization:	Asynchronous
Speed:	9,600/38,400/115,200bps

RS-232C

Control Protocol:	Full-duplex
Synchronization:	Asynchronous
Speed:	1,200 to 115,200bps

RS-422

Control Protocol:	Full-duplex
Synchronization:	Asynchronous
Speed:	9,600/38,400/115,200bps

Charger

Charge Method:	Fixed voltage (with current limiter)
Charge Time:	Approx. 6 hours

Power Supply

Power Source:	AC adaptor (AD-S42120AE)
Power Requirements:	AC100 to 240V
Rated Input:	DC 12 V, approx. 3,500 mA (during charging)

Functions

Infrared interface
RS-232C interface
RS-422 interface

Dimensions and Weight

Desktop:	Approx. 110 (W) x 220 (D) x 100 (H) mm Approx. 470 g
Wall Mounted (with wall mount unit attached):	Approx. 110 (W) x 220 (D) x 110 (H) mm Approx. 480 g

Using the Cradle-type Battery Charger

The Cradle-type Battery Charger (DT-969CHGE) makes it possible to separately charge battery pack installed in the Handheld Terminal and a spare battery pack (DT-923LIB) installed in the spare battery compartment on the charger.

The Cradle-type Battery Charger can be located on a desk or table top, or mounted on a wall. When the Cradle-type Battery Charger is mounted on a wall, be sure to use the wall mount unit (supplied).

General Guide

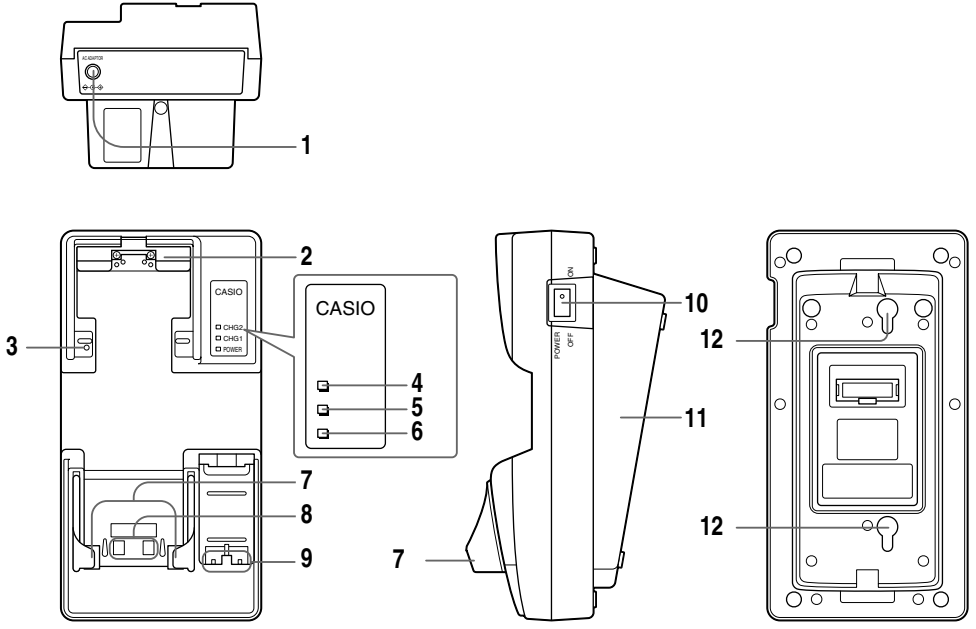

Accessories

Spacers



Wall mount guides



Wood screws

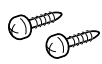

Wall unit screws

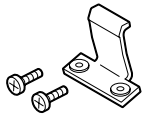

1	AC adaptor jack	For connection of the AC adaptor to supply power
2	Nose Guide	Remove this guide when you are using the down-facing reader port model.
3	Terminal detection switch	Detects whether or not the Handheld Terminal is mounted correctly on the Cradle-type Battery Charger
4	Spare battery pack charge indicator ("CHG 2")	Indicates the charge status of a spare battery pack installed in the spare battery compartment. Off: Not charging, or a battery pack problem Lit Red: Charging (charging standing by when the battery in the Handheld Terminal is charging) Lit Green: Charging complete
5	Battery pack charge indicator ("CHG 1")	Indicates the charge status of the lithium-ion battery pack in the Handheld Terminal. Off: Not charging (e.g. lithium-ion battery not loaded in Handheld Terminal) or a battery pack problem Lit Red: Charging Lit Green: Charging complete
6	Power indicator ("READY/POWER")	Indicates whether power is ON or OFF, and if the Handheld Terminal is mounted. Off: Power OFF Lit Red: Power ON, Handheld Terminal not mounted Lit Green: Power ON, Handheld Terminal mounted
7	Desktop guides (L, R)	Holds down the Handheld Terminal on the Cradle-type Battery Charger that is placed on a flat surface in desktop configuration.
8	Charge/Power supply terminals	Supplies power to the Handheld Terminal mounted on the Cradle-type Battery Charger.
9	Battery pack charge terminals	Charges the spare battery pack separately.
10	Power switch	Turns power ON and OFF.
11	Base	Reverses the position of the base when wall-mounting the Cradle-type Battery Charger.
12	Wall mounting holes	Use these holes to attach the Cradle-type Battery Charger to hook on a wall.

When You Are Using the Down-facing Reader Port Model

When you are using a down-facing reader port model, remove the nose guide before use. To remove the nose guide, remove the two screws using a screwdriver.

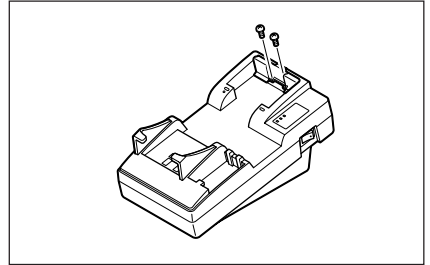

Setting up the Cradle-type Battery Charger

Use only the AC adaptor specified for use with the Handheld Terminal to connect to an electrical outlet. Be sure to connect the AC adaptor and turn Handheld Terminal power on before attempting to charge battery pack.

- 1** Remove the two desktop guides, L and R, installed on the charger by sliding them toward the rear side as shown in the illustration.

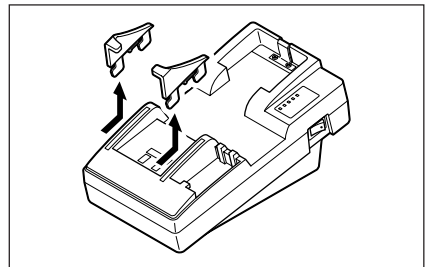

- 2** Insert the desktop guides, L and R, one at a time that were accompanied with DT-930 into each slit and then slide them toward the front side as shown in the illustration.

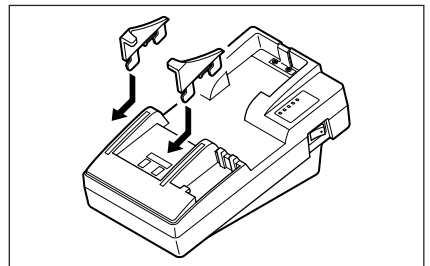

- 3** Plug the AC adaptor into an electrical outlet.
- 4** After making sure that the power switch of the Cradle-type Battery Charger is at the OFF position, plug the other end of the AC adaptor into the AC adaptor jack at the rear side of the charger.
- 5** Turn on the Cradle-type Battery Charger. The power indicator on the Cradle-type Battery Charger lights red.

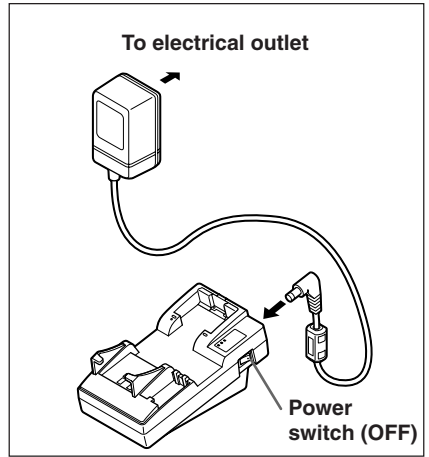

- 6** Attach the Handheld Terminal to the Cradle-type Battery Charger, making sure the charge terminals on the back of the Handheld Terminal come into contact with the terminals of the Cradle-type Battery Charger. If the Handheld Terminal is attached properly, the power indicator lights green. Start of charging is indicated by the charge indicator ("CHG 1") lighting red.

Charge Indicator ("CHG 1")

- Lit Red: Charging
- Lit Green: Charge complete
- OFF: No battery pack (DT-923LIB) installed.

Charging Time

Approx. 6 hours

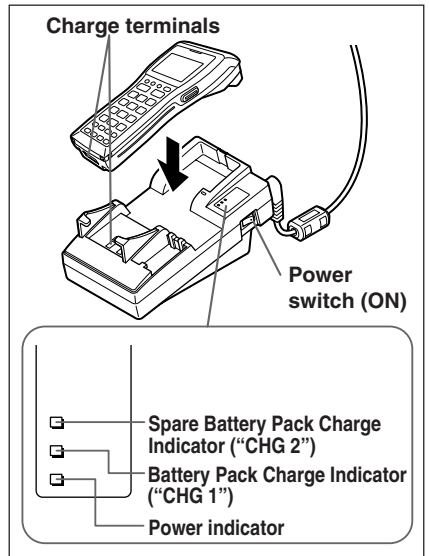

[Caution]

■ Ambient Temperature Ranges for the Battery Pack



- Temperature ranges for battery pack use in the Handheld Terminal, charging, and storage are specified below. Temperatures outside these ranges create the danger of deterioration of battery pack performance and shortening of its service life, as well as fluid leakage and heat generation.

Operating Temperature: -20°C to 50°C

Charging Temperature: 0°C to 40°C

Storage Temperature: -20°C to 60°C

Important!

- If the charge indicator does not light during charging, remove the battery pack and then re-attach it. If this does not solve the problem, it means that the battery pack is defective and needs to be replaced.
- Use only the specified battery pack.
- Battery packs naturally discharge even when they are not loaded in the Handheld Terminal. Use a battery pack as soon as possible after charging it.
- For best charging results, keep the Cradle-type Battery Charger, Handheld Terminal and battery pack contacts clean by periodically wiping them off with a cotton swab or dry cloth.
- “L” (for left) or “R” (for right) marking is imprinted on the back of each desktop guide and wall mount guide both accompanied with DT-930. Be sure to install the new guides properly on the Cradle-type Battery Charger, the desktop guides for desktop configuration or the wall mount guides for wall mount configuration. The use of the charger with DT-930 without replacing the original guides come installed on it with the new guides will result in improper charging battery pack.
- However, the use of the charger with the new guides installed for DT-900 does not result in the error.

Charging the Battery Pack (charging the lithium-ion battery pack separately)

1 Set the power switch of the Cradle-type Battery Charger to the ON position. The power indicator of the Cradle-type Battery Charger lights red.

2 Load a battery pack in the spare battery compartment on the charger, making sure that the terminals on the side and rear of the battery pack come into close contact with the battery pack charge terminals. The battery pack charge indicator ("CHG 2") lights red, and charging is started.

Battery Pack Charge Indicator ("CHG 2")

Lit Red: Charging (charging standing by when the battery in the Handheld Terminal is charging)

OFF: No battery pack (DT-923LIB) installed.

Lit Green: Charging complete

- When the battery pack charge indicator lights red and then goes out after several seconds, this indicates a battery pack problem.
- Charging simultaneously both the battery packs in the Handheld Terminal and in the spare battery compartment cannot be performed. Charging the battery pack in the Handheld Terminal is given its precedence.

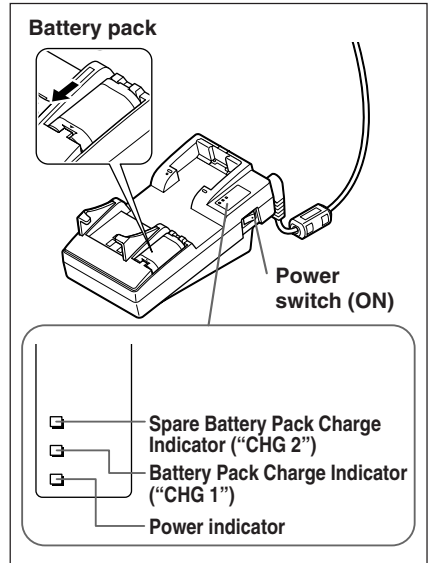

[Caution]

■ **Ambient Temperature Ranges for the Battery Pack**



- Temperature ranges for battery pack use in the Handheld Terminal, charging, and storage are specified below. Temperatures outside these ranges create the danger of deterioration of battery pack performance and shortening of its service life, as well as fluid leakage and heat generation.

Operating Temperature: -20°C to 50°C

Charging Temperature: 0°C to 40°C

Storage Temperature: -20°C to 60°C

Important!

- If the battery pack charge indicator does not light during charging, remove the battery pack and then re-attach it. If this does not solve the problem, it means that the battery pack is defective and needs to be replaced.
- Use only the specified battery pack.
- Battery packs naturally discharge even when they are not loaded in the Handheld Terminal. Use a battery pack as soon as possible after charging it.
- For best charging results, keep the Cradle-type Battery Charger, Handheld Terminal and battery pack contacts clean by periodically wiping them off with a cotton swab or dry cloth.

DT-969CHGE Cradle-type Battery Charger Specifications

Charger

Charge Method: Fixed voltage (with current limiter)
Charge Time: Approx. 6 hours

Power Supply

Power Source: AC adaptor (DT-9020ADP-GS or DT-9020ADP-US)
Power Requirements: 230 VAC (DT-9020ADP-GS)
120 VAC (DT-9020ADP-US)
Rated Input: DC 9.5 V, approx. 1,000 mA

Dimensions and Weight

Desktop: Approx. 110 (W) x 220 (D) x 100 (H) mm
Approx. 420 g
Wall Mounted (with wall mount unit attached):
Approx. 110 (W) x 220 (D) x 110 (H) mm
Approx. 430 g

■ Installing Cradles and Cradle-type Battery Charger

The following installation methods describe how to install the Basic Cradle, Satellite Cradle and Cradle-type Battery charger either on a flat surface place or on a wall.

To hang the cradles and charger on a wall

The following installation method is described with the Satellite Cradle as its reference.

- 1** Attach the wall unit screw.
When you are using the down-facing reader port model, remove the nose guide attached to the Handheld Terminal, and attach the wall unit screw to A using the screws (supplied).
When you are using the forward-facing reader port model, attach the wall unit screw to B using the screws (supplied) with the nose guide still attached.

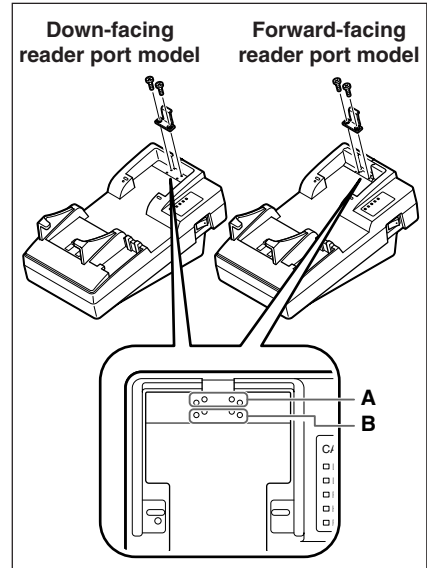

- 2** Remove the desktop guides (L, R).

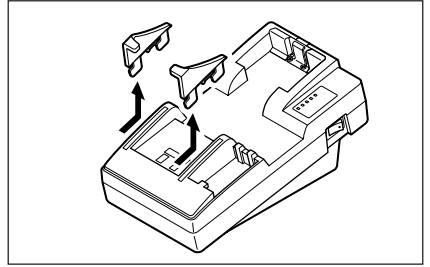

- 3** Attach the wall mount guides provided with the DT-930. Insert the wall mount guides into the slits, and then fix them in place by sliding them downwards.

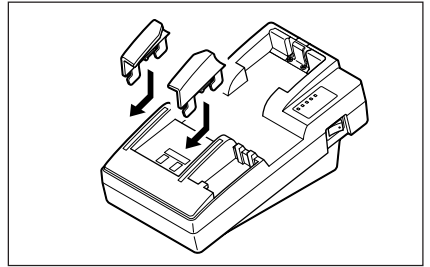

- 4** Remove the two screws (one each at the top and bottom) that secure the base to the Satellite Cradle.

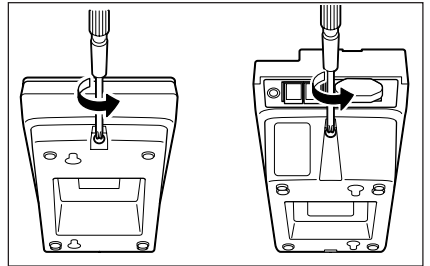

- 5** Pressing down on the four corners of the Satellite Cradle base, unhook the tabs, and remove the base from the unit.

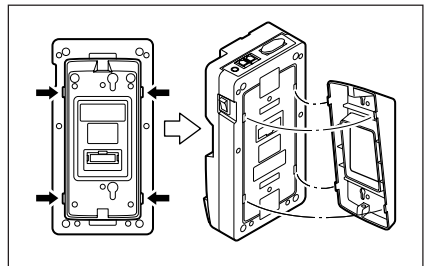

- 6** Position the base on the wall where you want to hang the Satellite Cradle, and use an awl or some other sharp object to mark the positions of the two wood screws.

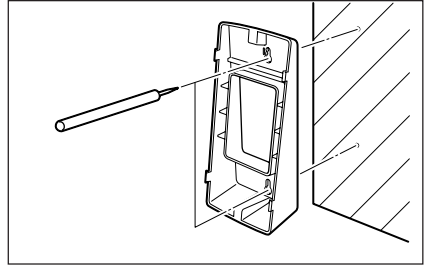

- 7** Slip a spacer over each of the wood screws and then drive the screws into the wall at the positions you marked in the previous step. Make sure that the spacers are oriented correctly. You will not be able to hook the Satellite Cradle onto the screws if the spacers are backwards.

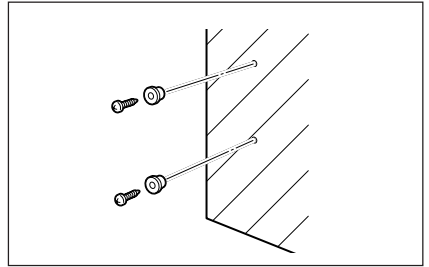

- 8** Re-attach the base to the Satellite Cradle, orienting it upside-down from its original mounting position when you removed it, and secure it in place with the two screws.

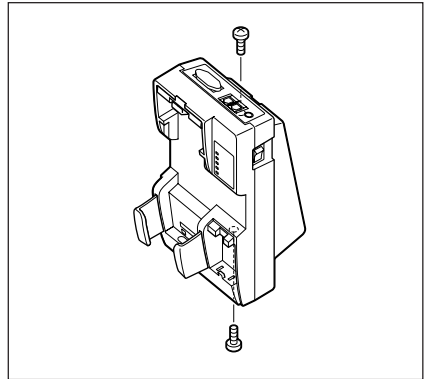

- 9** Hook the Satellite Cradle onto the wall unit screws in the wall, and slide it down to lock in place.

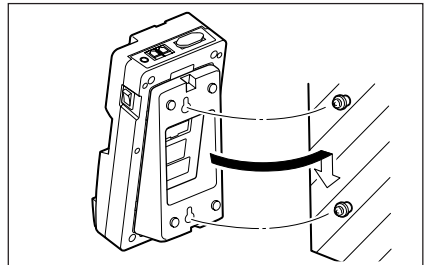

Important! • Be sure to check the wood screws periodically for looseness and tighten if necessary after hanging the Satellite Cradle on a wall.